

User Manual

Issue 1
Date 2023-08-15

SieB-H(9800-26K2)-M

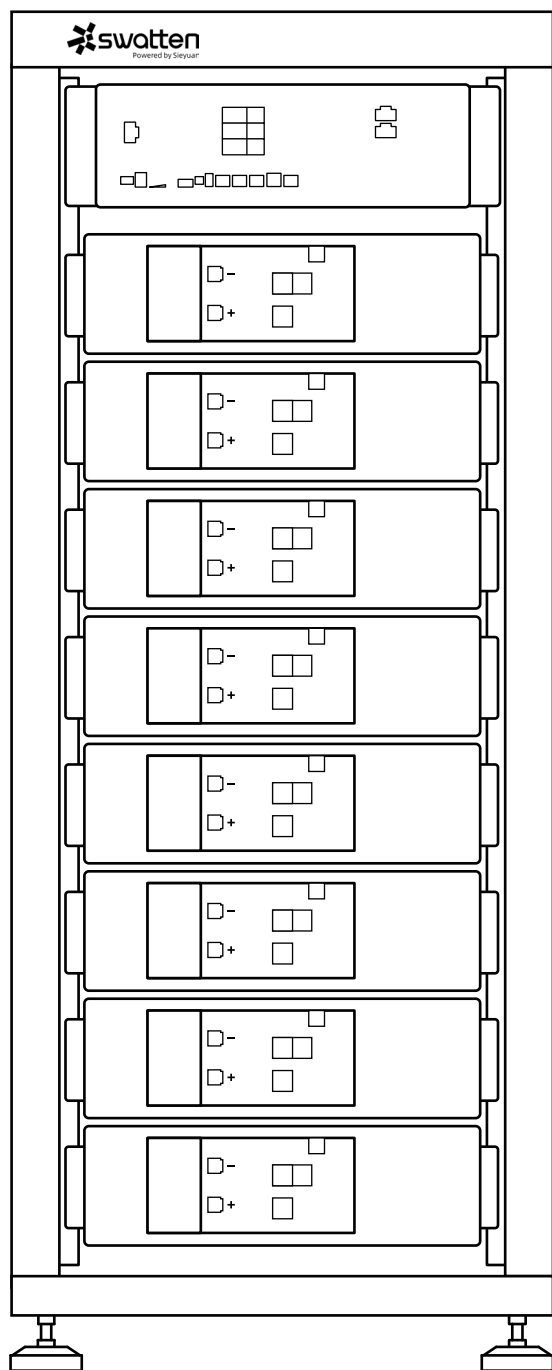

All Rights Reserved

- **All Rights Reserved**

No part of this document can be reproduced in any form or by any means without the prior written permission of Shanghai Sieyuan Watten Technology Co., Ltd.(hereinafter "Swatten").

- **Trademarks**

Swatten and other Swatten trademarks used in this manual are owned by Swatten.

All other trademarks or registered trademarks mentioned in this manual are owned by their respective owners.

- **Software Licenses**

- It is prohibited to use data contained in firmware or software developed by Swatten, in part or in full, for commercial purposes by any means.
- It is prohibited to perform reverse engineering, cracking, or any other operations that compromise the original program design of the software developed by Swatten.

Shanghai Sieyuan Watten Technology Co., Ltd.

Address: No. 3399 Huaning Rd.
Minhang District,
Shanghai 201100
P. R. China

Website: <https://www.swatten.com>

About This Manual

The manual primarily encompasses product information, along with installation, operation, and maintenance guidelines.

It will refer to the device as the "inverter" unless otherwise specified.

- Target Audience

This manual is intended for professional technicians who have responsibilities for the installation, operation, and maintenance of inverters, as well as users who need to check inverter parameters.

Installation Requirements:

The installation of the inverter should only be carried out by professional technicians who meet the following requirements

- Possess knowledge of electronics, electrical wiring, and mechanical expertise, and be familiar with electrical and mechanical schematics.
- Have received professional training related to the installation and commissioning of electrical equipment.
- Capable of promptly responding to hazards or emergencies that may arise during the installation and commissioning process.
- Familiar with local standards and relevant safety regulations pertaining to electrical systems.
- Thoroughly read this manual and understand the safety instructions associated with the operations.

- How to Use This Manual

- Please carefully read this manual before utilizing the product and store it in a readily accessible location.
- All content, images, trademarks, and symbols in this manual are the property of Swatten. No part of this document may be reproduced by individuals not employed by Swatten without written authorization.
- The contents of this manual may be periodically updated or revised, and the specifications of the actual product purchased should take precedence.

- **Symbols**

This manual incorporates crucial safety instructions that are emphasized using specific symbols. These symbols are employed to ensure the safety of individuals and property during product usage or to assist in maximizing product performance efficiently..

It is essential to thoroughly comprehend the significance of the warning symbols to enhance your utilization of the manual.

DANGER

Indicates the presence of high-risk potential hazards that, if not avoided, could result in severe injury or even death.

WARNING

Indicates the presence of moderate-risk potential hazards that, if not avoided, could result in serious injury or even death.

CAUTION

Indicates the presence of low-risk potential hazards that, if not avoided, may lead to minor or moderate injury.

NOTICE

Indicates potential risks that, if not avoided, may result in device malfunctions or financial losses.

The "NOTE" designation is used to indicate supplementary information, emphasized content, or helpful tips that can assist you, such as problem-solving techniques or time-saving suggestions.

Change History

Changes between document issues are cumulative, meaning that each subsequent document issue includes all the changes made in earlier issues.

Issue 1 (2023-08-15)

This issue is the first official release.

Contents

1 Important Safety Information	1
1.1 Warning Label	1
1.2 Safety Precautions	3
2 Product Introduction	4
2.1 Product Features	4
2.2 Application Scenarios	4
2.3 Appearance and Terminals	5
2.4 Technical Parameters	8
3 What You Need	11
3.1 Installation and O&M Tools	11
3.2 Protective Equipment	11
4 Storage and Installation	12
4.1 Storage	12
4.2 Unpacking Inspection	12
4.3 Installation of Battery	12
4.3.1 Installation Requirements	12
4.3.2 Installation Process	13
5 Electrical Connection	15
5.1 Prepare Cables	16
5.2 Connect Cables	16
5.2.1 Wiring Within a Rack	17
5.2.2 Wiring Between Racks	18
6 Operation and Commissioning	20
6.1 Power on System	20
6.2 Power off System	20
7 Maintenance	21
7.1 Recharge Battery	21
7.2 Replace Battery	21
7.3 Upgrade Firmware	21
8 Product Liability	23
9 Recycle	24
10 Regulation Compliance	25
10.1 UN 38.3	25
11 Appendix	26
11.1 A Protection Policy	25
11.2 Technical Data	25

1 Important Safety Information

1.1 Warning Label



Do not dispose battery in household trash



Recyclable.



Certification in European Union area.



Risk of electric shock.



Explosive gas.



Battery may leak corrosive electrolyte.



Battery is heavy enough to cause severe injury.



Keep battery away from children.



Do not reverse polarities.



Do not expose battery to flame.



Operate as specified by the manual.



Read the manual before operating.

Nameplate

Module

Swatten	
Lithium Ion Battery	
IFpP16/122/360/[16S]M/-10+50/90	
Model	SieB-H3277-M
Nominal Voltage	51.2V
Total/Rated Capacity	64Ah/62.4Ah
Total/Rated Energy	3.27kWh/3.19kWh
Ingress Protection	IP20
Operating Ambient Temperature	-10°C~50°C
Max. Short Current and Duration	1900A, 30ms
Operating Voltage Range	40V~57.6V
Max. Charge/Discharge Current	52.5A
Max. Charge/Discharge Power	2.52kW
Protection Class	I

Made in China

HVB Box

Swatten	
HV BOX	
HV BOX Model: SieB-H-M	
Operating Ambient Temperature: -10°C~50°C	
Ingress Protection: IP20	
Protection Class: I	
No. of Modules /Nominal Voltage/Energy/	
Input & Output Power	
<input type="checkbox"/>	3S/153.6VDC/9.06kWh/7.56kW
<input type="checkbox"/>	4S/204.8VDC/12.08kWh/10.08kW
<input type="checkbox"/>	5S/256.0VDC/15.10kWh/12.60kW
<input type="checkbox"/>	6S/307.2VDC/18.11kWh/15.12kW
<input type="checkbox"/>	7S/358.4VDC/21.13kWh/17.64kW
<input type="checkbox"/>	8S/409.6VDC/24.15kWh/20.16kW

Made in China

Label

WARNING AVERTISSEMENT

1. Do not disassemble or alter the battery in any way.
Ne démontez ni modifiez la batterie en aucune façon.
2. Do not use the battery for purposes not described in its documentation.
N'utilisez pas la batterie à des fins non décrites dans sa documentation.
3. Do not drop, strike, puncture, or step on the battery.
Ne laissez pas tomber, ne heurtez pas, ne percez pas et ne marchez pas sur la batterie.
4. In case of electrolyte leakage, keep leaked electrolyte away from contact with eyes or skin, immediately clean with water and seek help from a doctor.
En cas de fuite d'électrolyte, gardez l'électrolyte qui fuit loin du contact avec les yeux ou la peau, nettoyez immédiatement avec de l'eau et demander de l'aide à un médecin.
5. Do not put the battery into a fire. Do not use it or leave it in a place near fire, heaters, or high temperature sources.
Ne mettez pas la batterie au feu. Ne l'utilisez pas et ne le laissez pas dans un endroit près de feu, de radiateurs ou de sources de températures élevées.
6. Do not submerge the battery in water, or expose it to moisture.
Ne plongez pas la batterie dans l'eau et ne l'exposez pas à l'humidité.
7. Do not allow the terminals to contact exposed wire or metal.
Ne laissez pas les bornes entrer en contact avec du fil ou du métal exposé.
8. The battery is heavy and can cause injury if not handled safely.
La batterie est lourde et peut provoquer des blessures si elle n'est pas manipulée en toute sécurité.
9. Keep out of reach of children or animals. Tenir hors de portée des enfants ou des animaux.

1.2 Safety Precautions

Risks of Electrolyte Leakage:

- Avoid subjecting the battery to strong impacts or crushing/puncturing it.
- Prevent the battery from falling, and if it does, turn it off immediately and stop using it.
- Do not open or mutilate batteries, as the released electrolyte is harmful to the skin and eyes.

Risks of Fire:

- Keep the battery away from direct sunlight.
- Avoid contact with conductive objects like wires.
- Ensure the battery is away from fire sources, inflammable, explosive, and chemical materials.
- Never dispose of batteries in a fire.

Risks of Electric Shock:

- Do not touch the battery with wet hands.
- Keep the battery out of reach of children and animals.
- High short-circuited current in a battery can cause electric shock and burns.
- Battery installation and wire connections should only be handled by professionals.

Risks of Damage:

- Keep a distance from water sources to prevent damage to the battery.
- Avoid exposing the battery to high voltage.
- Place the battery on a flat surface and avoid placing any foreign objects or stepping on it.
- Ensure battery-connected PCS (Power Control System) has reinforced insulation.

Table 1-1 Responses to Emergencies

Event	Description and Recommended Actions
Leakage	<ul style="list-style-type: none"> • Inhalation: Immediately leave the contaminated area. • Swallowing: Induce vomiting. • Contact with Eyes: Flush eyes with flowing water for 15 minutes. • Contact with Skin: Thoroughly wash affected area with soap and water. • After taking emergency measures, seek immediate medical attention.
Fire	<p>In case of heating above 150°C, take immediate following action to prevent the battery from catching fire:</p> <ul style="list-style-type: none"> • Use ABC or carbon dioxide extinguisher to extinguish any small fires before they escalate. • If the fire is uncontrollable, promptly evacuate people to a safe location before seeking assistance from professional fire protection personnel. • Ensure personal safety is a priority while dealing with fire incidents involving the battery.
Wet battery	If the battery becomes wet or has been submerged in water, avoid handling it. Contact your distributor immediately for technical assistance.
Damage	A damaged battery is hazardous and should be handled with extreme caution. It must not be used anymore as it could pose a safety risk to people and property. If you suspect the battery is damaged, cease all operations and promptly return it to the distributor.

2 Product Introduction

The 64Ah HV battery system is designed for residential energy storage and consists of battery modules as the primary power supply unit and the HV Box as the battery management unit. The battery module is built using 64Ah cells arranged in 1 parallel and 16 series configuration.

2.1 Product Features

Compared to regular batteries, the battery system exhibits superior charging and discharging performance, an extended cycle life, and reduced self-discharge loss. It allows up to 8 battery modules to be connected in series, expanding the energy and power capacity of the energy storage system. Communication with the PCS is facilitated through CAN or RS485 network ports. The HV Box oversees battery operation and issues timely alarms to prevent any operation exceeding the limits.

- **Monitoring**
Monitors cell voltage, cell temperature, battery voltage, and current.
- **SOC Estimate**
Provides accurate estimation of the remaining electricity volume.
- **Alarm**
Triggers an alarm in case of overvoltage, undervoltage, overcurrent, over temperature, or under temperature.
- **Protection**
Offers protection against overvoltage, undervoltage, overcurrent, over temperature, under temperature, cell fault, and hardware failure.
- **Report**
Sends alarm messages and operation data to PCS via CAN or RS485 network ports.
- **Series Connection**
Supports up to 8 battery modules in series connection.
- **Fault-triggered Power-off**
The battery powers off in the event of level three undervoltage, 0V cell, or series connection failure.
- **Forced Power-off**
When the battery system is not connected to the mains supply, turning OFF the breaker switch on the HV Box powers off the battery modules.
- **Activation**
By applying 100V to 500V through the P+/P- terminals, the battery can be activated from off mode to standby status.

2.2 Application Scenarios

The battery system collaborates with PCS (Power Control System) and loads in the residential energy storage system. It functions by storing energy generated by a photovoltaic system (PV) or obtained from the grid. The stored energy is then utilized to provide power when the PV system is not generating or the grid supply is unavailable.

Figure 2-1 Application Scenario

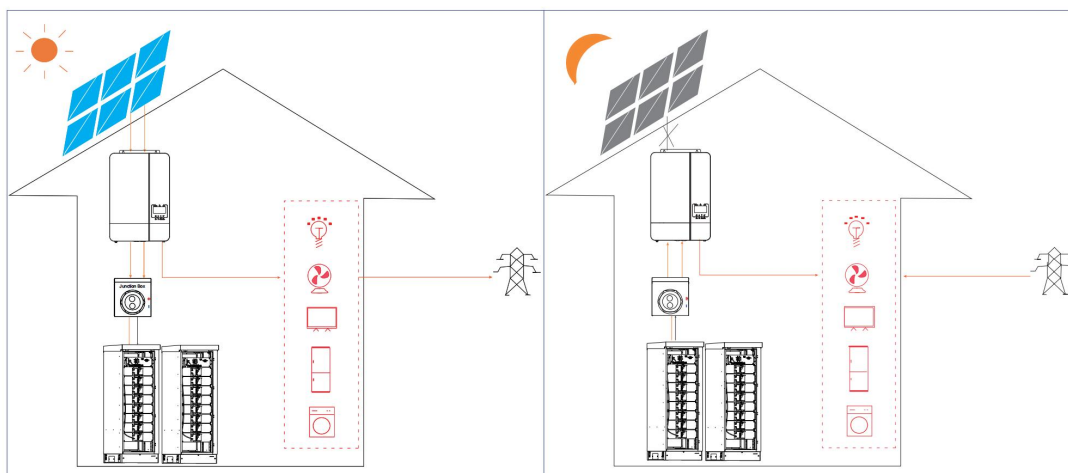

The PV system optimizes energy for loads, and excess energy charges the battery before exporting to the grid.

Battery powers nighttime loads when PV is unavailable. If battery energy is insufficient, it supplements loads with grid power.

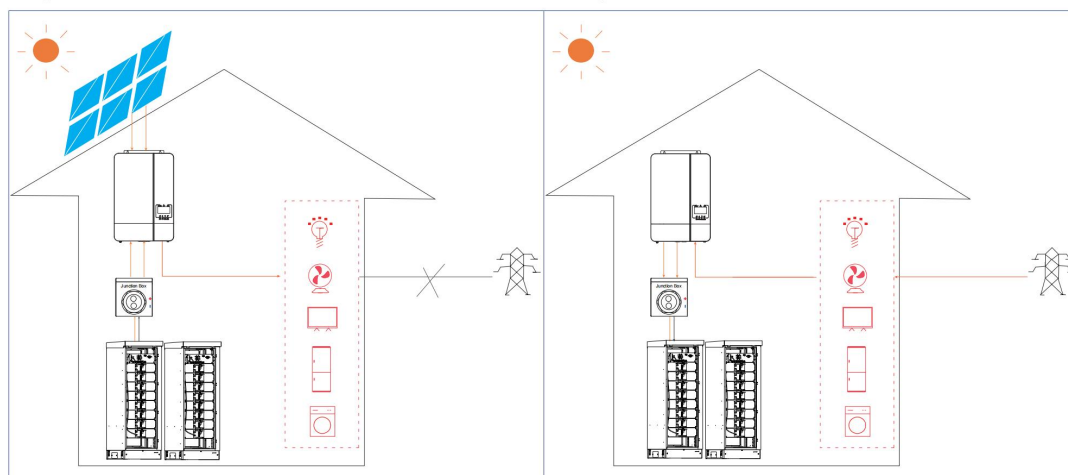

During grid outages, loads can be powered by the battery and PV system.

Battery can be charged using grid power. It is advisable for users to store energy from the grid to the battery during periods of lower electricity prices.

2.3 Appearance and Terminals

The battery system is composed of battery modules and HV box.

Table 2-1 Mechanical features

Parameter	Module	HV Box
Dimension	W445*D377*H131mm	W400*D188*H131mm
Weight	27.5kg (for reference only)	6kg (for reference only)
Installation	Rack-mounted installation	Rack-mounted installation

Figure 2-2 HV Box

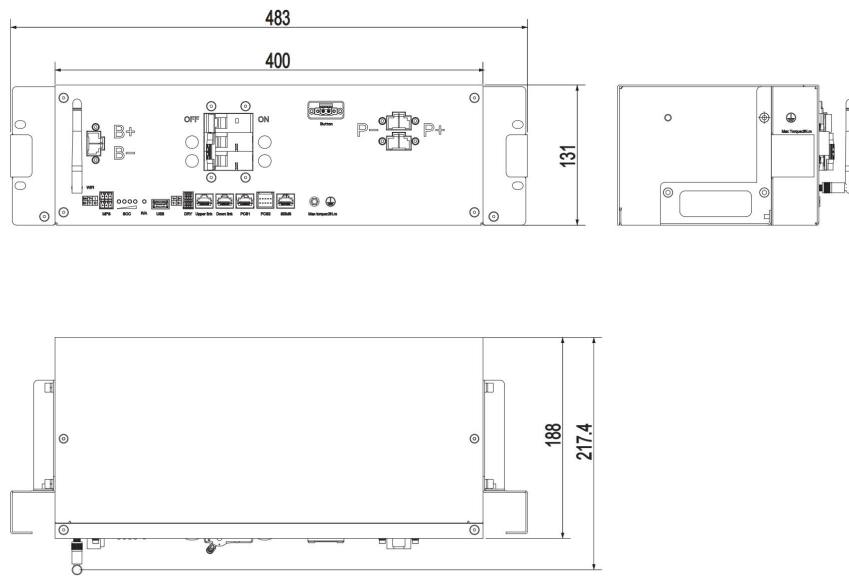

Figure 2-3 Module

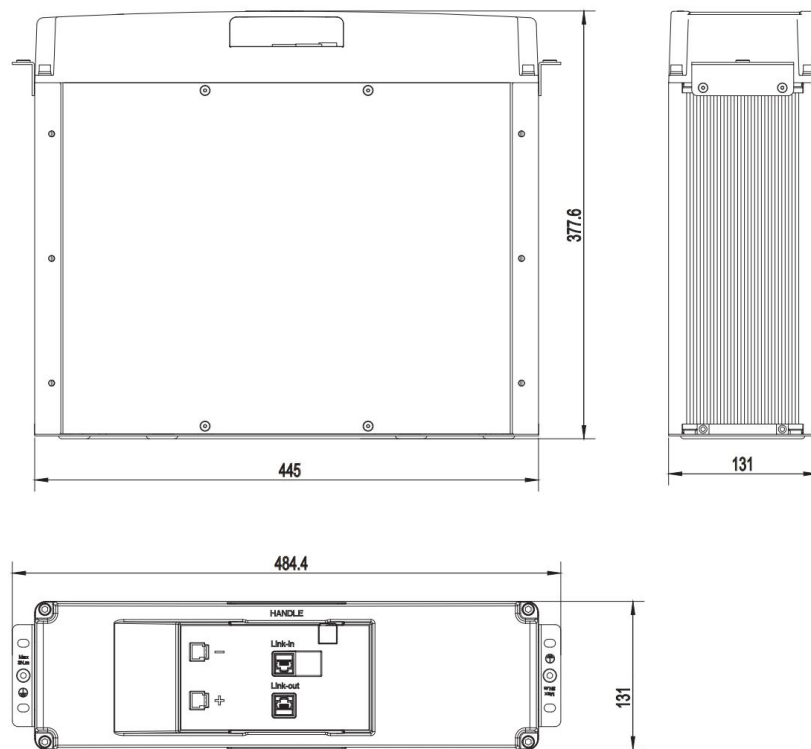

Figure 2-4 HV Box panel

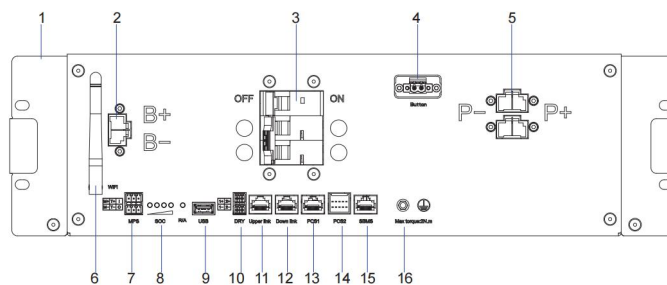



Table 2-2 Ports and terminals

No.	Label	Description
1	Bracket	To fix the HV Box to a rack
2	B+/B-	Positive and negative input port
3	ON/OFF	Breaker switch
4	Button	Start button interface
5	P+/P-	Positive and negative output port between battery system and PCS
6	WiFi	Wi-Fi antenna
7	MPS port	Maintenance power supply, external environment sampling, door access sensor
8	LED indicators	SOC: Indicating the battery SOC R/A: Indicating the running status and faults
9	USB	Software upgrade and history data export port
10	DRY	Output Dry interface
11	Upper link	Input port for parallel connection
12	Down link	Output port for parallel connection
13	PCS1	RJ45 PCS communication port
14	PCS2	JST PCS communication port
15	SBMS	Module communication port
16		Grounding terminal

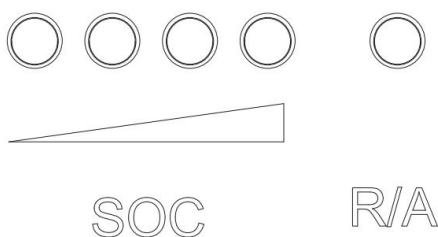

Table 2-3 LED indicators

PACK Status	PACK Information	Display Logic				Bi-color	Remark
		LED1	LED2	LED3	LED4	LED5	
Charging	0%-25.0% SOC	■				●	Flash LED (water light), 1Hz
	25.1%-50.0% SOC	■	■			●	Flash LED (water light), 1Hz
	50.1%-75.0% SOC	■	■	■		●	Flash LED (water light), 1Hz
	75.1%-99.9% SOC	■	■	■	■	●	Flash LED (water light), 1Hz
	100% SOC	●	●	●	●	●	
Discharging & Standby	100%-75.1%	●	●	●	●	●	
	75.0%-50.1%	●	●	●		●	
	50.0%-25.1%	●	●			●	
	25.0%-0%	●				●	

■ LED flash

● LED on

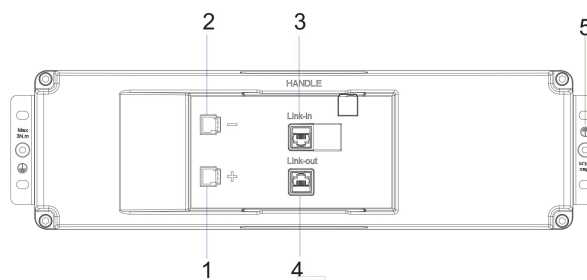

Table 2-4 Ports and terminals of module

No.	Label	Description
1	+	Positive output of module
2	-	Negative output of module
3	Link-out	Communication output of series connection
4	Link-in	Communication input of series connection
5		Grounding terminal

2.4 Technical Parameters

No.	Parameter	Value
1	Total capacity	64Ah
2	Rated/Usable capacity	58.97Ah ¹
3	Max. charge current	-10°C≤T≤0°C, 10.6A 0°C≤T≤5°C, 16A 5°C≤T≤15°C, 32A 15°C≤T≤45°C, 52.5A 45°C≤T≤50°C, 32A 50°C≤T≤55°C, 16A
4	Max. discharge current	-10°C≤T≤0°C, 10.6A 0°C≤T≤45°C, 52.5A 45°C≤T≤50°C, 42.6A 50°C≤T≤55°C, 16A
5	Peak charge/discharge current (5S)	61.95A
6	Room Temperature Calendar Life (25°C±2°C)	≥15 years (warranty)
7	Room Temperature Cycle Life (25°C±2°C)	≥6000 cycles/ 60%EOL
8	Operating ambient temperature	-10°C ~50°C
9	Optimal operating temperature	15°C ~30°C
10	Operating ambient humidity	5%~95%
11	RTE	≥95%
12	Discharge rate of Module	≤1.5%/month/@25°C
13	Module Series connection	3S~8S
14	Rack Parallel connection	4 units in parallel
15	Cooling	Natural cooling
16	Altitude	≤2000m
17	Communication port (with module)	CAN (one port)
18	Communication port (between battery systems)	CAN (two ports)

19	Communication between PCS and battery system	CAN/RS485 (one port)
20	Regulation compliance	IEC62619/JISC8715-2
21	Certification	/
22	EMC standard	EN61000-6-1 &EN61000-6-3
23	UN Transportation Test Standard	UN38.3
24	Ingress Protection	IP55
25	Environment protection standard	RoHS, REACH

Table 2-5 Electrical Parameters

Parameter	Specifications					
	3S	4S	5S	6S	7S	8S
Total energy (kWh)	9.83	13.11	16.38	19.66	22.94	26.21
Rated/Usable energy (kWh)	9.06	12.08	15.10	18.11	21.13	24.15
Nominal voltage (V)	153.6	204.8	256	307.2	358.4	409.6
Output voltage range (V)	144~172.8	192~230.4	240~288	288~345.6	336~403.2	384~460.8
Max. charge/discharge power (kW)	7.56	10.08	12.6	15.12	17.64	20.16
Peak charge/ discharge power (kW) (@25°C , 5S)	10.26	13.68	17.1	20.52	23.94	27.36

Table 2-6 Module specifications

No.	Items	Specifications
1	Total Capacity / Energy	64Ah/3.27kWh
2	Rated/Usable Capacity/Energy	58.97Ah/3.02kWh2
3	Nominal Voltage	51.2V
4	Output Voltage Range	40V~57.6V
5	Shipment Voltage	52.16V~53.04V
6	Module Safety Certification	JISC8715-1&2/ JISC6950-1
7	Cell Safety Certification	IEC62619/UL1973
8	UN Transportation Test Standard	UN38.3
9	Storage conditions	-30°C to 60°C /7days; -20°C to 45°C/6months, 95%RH
10	Ingress Protection	IP20
11	Altitude	≤2000m
12	Series Connection	Series connection voltage difference among modules $\Delta V \leq 1V$
13	Connection	16S1P
14	Shipment Capacity	30% SOC (voltage ranging between 3.292V±10mV)

Table 2-7 HV Box specifications

No.	Items	Specifications
1	Max. operating voltage range	96V~460.8V
2	Max. input/output current	52.5A
3	Peak input/output current (5S)	61.95A
4	Optimal operating temperature	15°C ~30°C
5	Environment temperature range	-10°C ~50°C
6	Communication Port between HV Box and Module	CAN2.0
7	Communication Port between HV Box and PCS or DC/DC	RS485
8	Max. Module Series Connections	8S
9	Ingress Protection	IP20

3 What You Need

3.1 Installation and O&M Tools

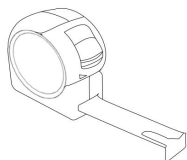

Tape measure



Screwdriver

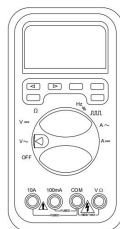

Multi-meter



Mark pencil

3.2 Protective Equipment



Insulated gloves



Safety goggles



Rubber boots

To prevent injury, always wear acid-resistant clothing, PVC gloves, goggles and rubber boots.

4 Storage and Installation

4.1 Storage

Battery storage life

Life	Temperature	Humidity
7 days	-30°C to -20°C or 45°C to 60°C	5%RH-95%RH
180 days	-20°C to 45°C	5%RH-95%RH

- If the battery is not used for more than 1 week, store it following the specified storage conditions.
- Position the battery according to the labeling on the packaging and avoid placing it upside down.
- Store batteries in a shaded and rain-free location.
- Maintain a minimum distance of two meters between the batteries and any heat source (e.g., radiator).
- Avoid exposure to corrosive substances and organic materials, including gases.
- Separate batteries with defects from normal ones by using walls or placing them in different fire protection zones.
- Ensure the storage area is dry, clean, and well-ventilated.
- Recharge batteries that have been stored for more than 6 months.
- Set the charging parameters to "CV=56V, CC=10A" and charge the battery for two hours until the terminal blocks measure between 52.8V and 56V.

4.2 Unpacking Inspection

Thoroughly examine the package for any signs of damage, such as holes, cracks, or other marks. If any package damages are noticed, refrain from opening it and promptly inform your distributor.

Once the package is opened, carefully inspect the battery for any damages, including cracks, dents, punctures, deformations, acid leaks, or any visible abnormalities. Also, ensure that all accessories listed in the packing list are present. If any part is missing or damaged, please notify your distributor.

For a detailed list of packing items, refer to the packing list provided in the carton box.

4.3 Installation of Battery

CAUTION

Avoid direct exposure of the battery to sunlight or rain.

Maintain a low level of dirt or dust around the battery.

Avoid installing the battery in areas prone to frequent flooding.

Avoid installation in highly humid environments.

Do not stack batteries during installation.

Ensure that the battery system is installed within its specified operation requirements for environmental conditions.

Ensure there is direct contact between the battery shell and ambient air, and refrain from covering or shielding the battery.

4.3.1 Installation Requirements

To ensure proper installation, it is advised to place the battery system indoors within a rack. However, if you choose to install it outdoors, make sure to select a rack with a suitable IP rating for outdoor use. Additionally, construct a sunshade and rain shelter to protect the battery from direct sunlight and rain exposure. This will help maintain the longevity and performance of the battery system.

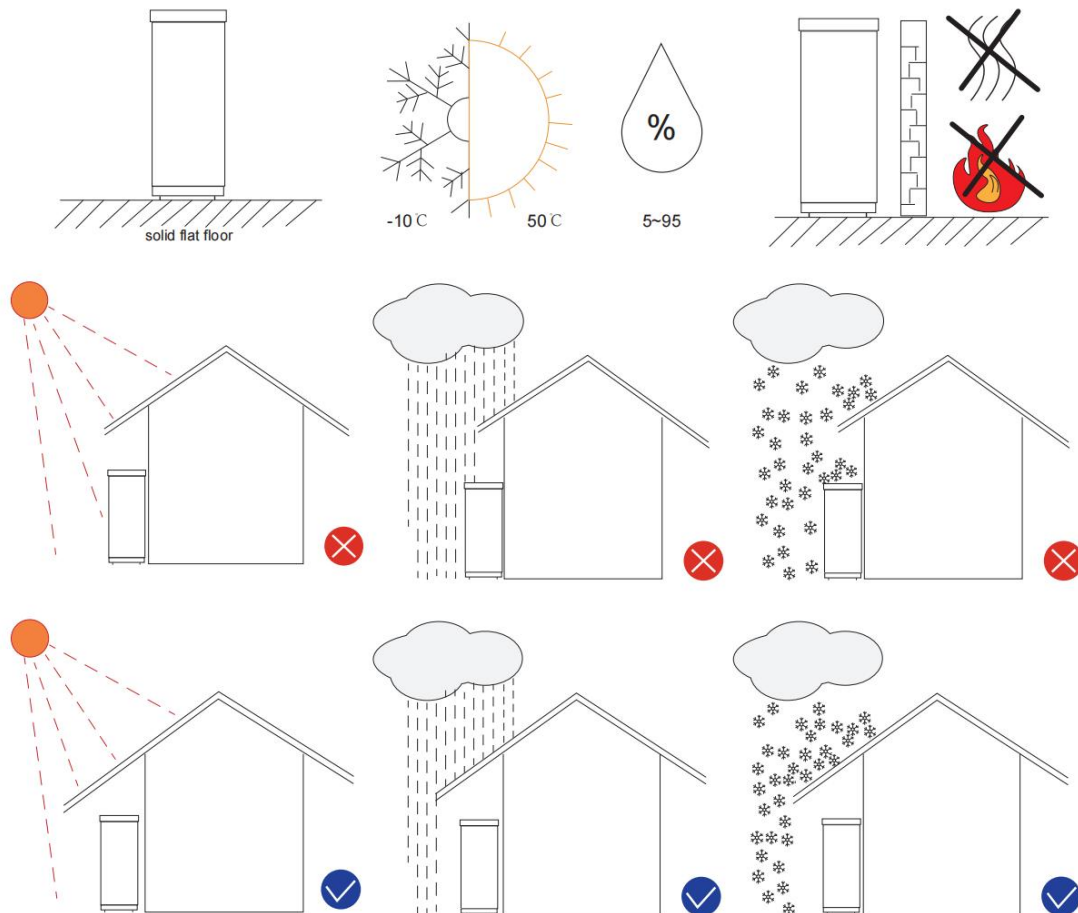

4.3.2 Installation Process

CAUTION

Installers should be well-trained and hold the necessary qualification certificates as required by local regulations.

Ensure that all switches of the HV Box are in the off position before proceeding with the installation.

Prior to installing the battery, ensure the use of safety goggles, insulation gloves, and safety shoes for personal protection. Remove any conductive accessories like watches, bracelets, and rings.

The weight of each battery is approximately 27.5 kg, and each HV Box weighs around 6 kg. Before installation, verify that the chosen rack can safely support the total weight.

Take note of the dimensions of the battery (W445D377H131 mm) and the HV Box (W400D188H131 mm).

Ensure that the rack has sufficient volume to accommodate these components.

To enhance the battery life, it is recommended to leave a gap greater than 3 mm between batteries to facilitate cooling.

Ensure the battery is powered off before starting any installation procedure. It is advisable to have assistance during the installation process.

Step 1: Turn off the HV Box by pulling the breaker switch to the OFF position.

Step 2: Carefully insert the battery modules into the rack and securely fasten them to the cabinet using screws, following the illustration provided.

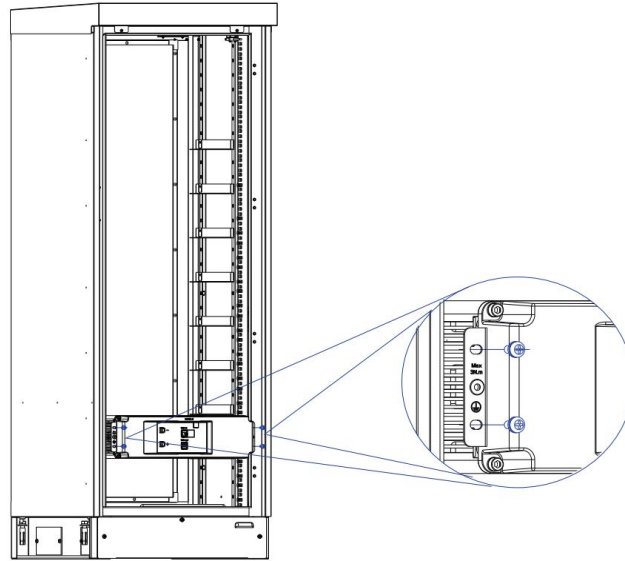

Step 3 Push the HV box into the rack and fasten it with screws

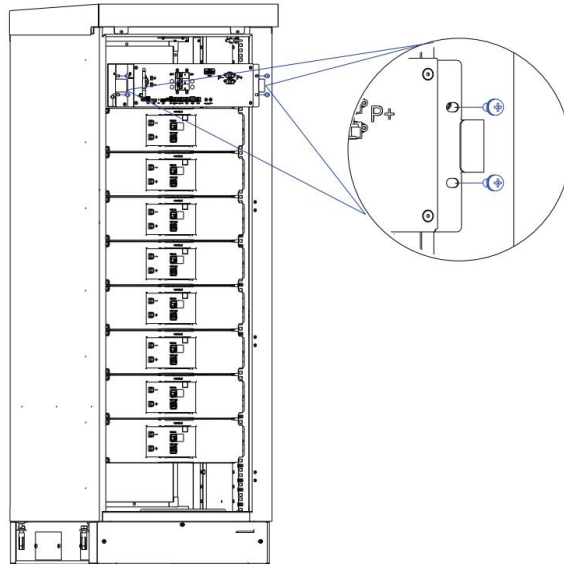

5 Electrical Connection

The HV Box and module provide the following network ports and power terminals for electrical connection.

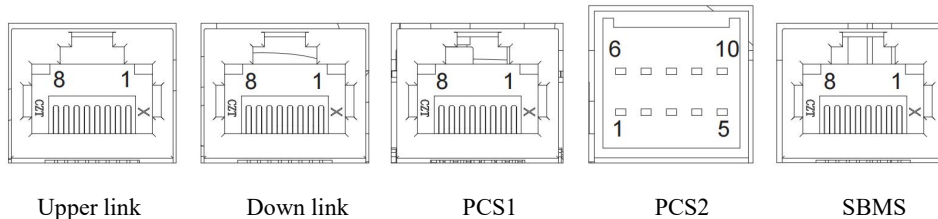

No.	Upper link	Down link	PCS1	PCS2	SBMS
1	CANH	CANH	PCS_485_B	Shut Down	CANH
2	CANL	CANL	PCS_485_A	Alarm	CANL
3	ID_IN	ID_OUT	Dry1+	PCS-RS485+A	FAULT
4	GND_C	GND_C	PCS_CANH	GND	S_POW-12V
5	Master address	Slave address	PCS_CANL	12V-Power	S_POW-12V
6	Dry-	Dry-	Dry-	PCS_CANH	ID_OUT
7	Dry+	Dry+	PCS_12V	PCS_CANL	GND_S
8	12V IN	12V OUT	PCS_GND	PCS-RS485-B	GND_S
9				Dry+	
10				GND	

Table 5-1 Module ports

No.	Link IN	Link OUT
1	CANH	CANH
2	CANL	CANL
3	FAULT	FAULT
4	S_POW-12V	S_POW-12V
5	S_POW-12V	S_POW-12V
6	ID_IN	ID_OUT
7	GND_S	GND_S
8	GND_S	GND_S



Figure 5-2 Power ports

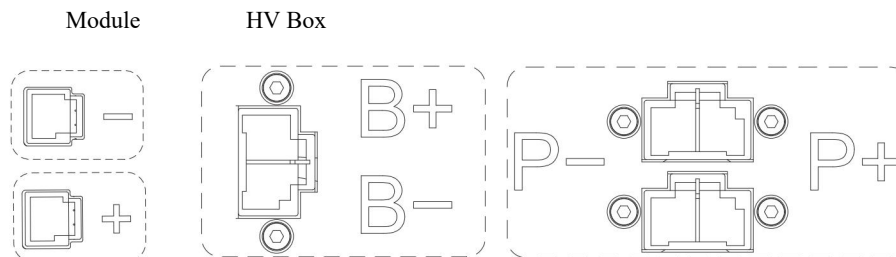

5.1 Prepare Cables

Swatten provides the following cables and wires for the electrical connection of 4 or 8 modules in series and one HV Box within a rack.

Table 5-2 Cable set for series connection

No.	Cable Name	4 Series	8 Series	Description	Remarks
1	Power cable A	1pcs	1pcs	Power cable between HVB and modules	he cable lengthes for 4 series and 8 series are different
2	Power cable B	3 pcs	7pcs	Power cable between modules in series connection	
3	Network cable	4pcs	8pcs	Communication cable between HV Box and module	

For other connections, you need to prepare wires and cables according to the connector specifications.

No.	Port/Terminal	Connector	Model Connector Type	Cable Cross-Section
1		HVB front panel	M4	8AWG
2		HVB side panel	M5	8AWG
3		Module hanger	M6	8AWG
4	Upper Link	CZT, 10221188F176	RJ45	AWG24x8
5	Down Link	CZT, 10221188F176	RJ45	AWG24x8
6	SBMS	CZT, 10221188F176	RJ45	AWG24x8
7	PCS1	CZT, 10221188F176	RJ45	AWG24x8
8	P+/P-	HRS, DF60-2EP-10.16C	CONN PLUG 10.16MM 2POS	8AWG
9	PCS2	JST, S10B-J21DK-GGXR	Crimp Style Connector (Wire-to-Board Style), 2.5 mm pitch, 10 positions, double row	(AWG28 to AWG20) x10
10	DRY	AMPHENOL, KE041151A000G	TERM BLOCK HDR 4POS 90DEG 3.5MM	AWG20x4
11	MPS	AMPHENOL, KE061151A000G	TERM BLOCK HDR 6POS 90DEG 3.5MM	AWG20x6

5.2 Connect Cables

The battery system allows customers to customize applications. Three to eight battery modules can be installed and connected in series within one rack and a maximum of four racks can be connected in parallel. This section describes how to wire modules and racks. Eight modules in series and four racks in parallel are describes as examples.

CAUTION

- Before performing any operations on batteries, ensure that all batteries and electrical units are powered off to avoid any risk of electric shock or injury.
- Always wear appropriate protective equipment, such as safety gloves and safety goggles, when handling batteries to protect yourself from potential hazards.
- After wiring the batteries, carefully inspect the cables to ensure that they are not twisted or tangled, as

this could lead to improper connections and potential issues.

- Verify that the batteries are manufactured within one year and have a cycle difference of less than 300 to ensure optimal performance and reliability.

5.2.1 Wiring Within a Rack

Wire modules and the HV box in the following process:

Step 1 Connect the grounding terminals on HV Box and modules to the grounding terminal of the rack and ground the rack.

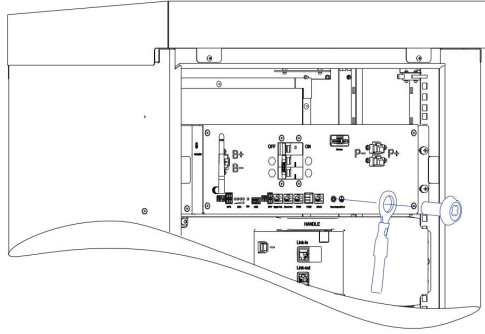

CAUTION

Please be aware that Swatten does not include the grounding wires required for this installation. It is your responsibility to select and provide the appropriate grounding wires based on the terminal specifications provided in this document.

Both the HV Box and modules have two grounding terminals each. You can choose one of the grounding terminals to ground both the HV Box and modules. Ensure that the selected grounding wire meets the necessary requirements and standards for a safe and reliable installation.

Step 2: Connect Network Cables

1. Use a network cable to establish a connection between the Link-in port of Module 1 and the SMBS port of the HV Box.
2. Insert one end of another network cable into the Link-out port of Module 1 and the other end into the Link-in port of Module 2.
3. Continue connecting Module 2 to Module 8 in the same manner.
4. If only one rack is being used, insert a crystal plug with pin 4 and pin 5 short-circuited into the Upper Link and Down Link ports of the HV Box, respectively.

Step 3: Connect Power Cables

1. Use a power cable to link one pair of HVB Box P+ and P- terminals to the +/- terminals of the PCS.
2. Utilize power cable A to connect the - terminal of Module 1 and the + terminal of the last module to the B-/B+ terminal of the HV Box.
3. Use power cable C to connect the + terminal of Module 1 to the - terminal of Module 2.
4. Continue connecting each subsequent module in a similar manner until reaching the last module.

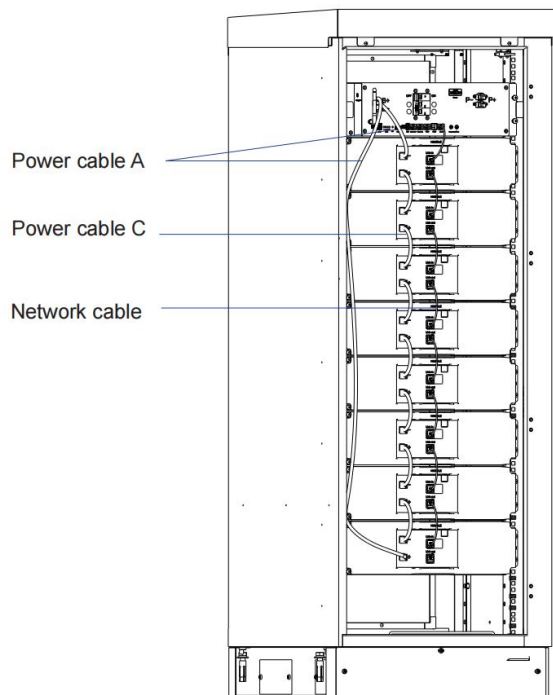

CAUTION

The HV Box offers two pairs of P+/P- terminals, and you have the flexibility to choose either one to connect to the PCS.

It is crucial to ensure the correct connection of the positive and negative terminals of the modules, HV Box, and PCS to avoid potential short circuits and prevent damage to the battery system.

5.2.2 Wiring Between Racks

Once the internal cable wiring within the racks is complete, you can proceed to parallelly connect up to 4 racks. Refer to the provided figures, where rack 1 to rack 4 should be connected sequentially from right to left. Follow these steps to wire the racks accordingly:

CAUTION

Please be aware that Swatten does not supply the wires or cables required for parallel connection of racks.

Step 1: Establish network connections between racks.

1. Place a crystal plug with pins 4 and 5 short-circuited into the Upper link port of the HV Box located in rack 1.
2. Connect the PCS1 port of the HV Box in rack 1 to the PCS.
3. Link the Down link port of the HV Box in rack 1 to the Upper link port of the HV Box in rack 2.
4. Repeat the same linking process from rack 2 to rack 3, and from rack 3 to rack 4.
5. Insert a crystal plug with pins 4 and 5 short-circuited into the Down link port of the HV Box in rack 4.

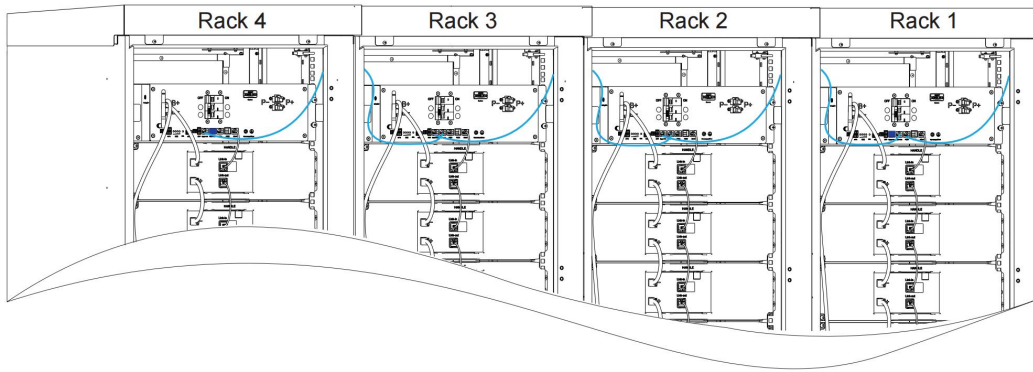

Step 2: Establish power connections between the racks.

1. Link the lower positive and negative power terminals of the HV Box in rack 1 to the power terminals of the PCS.
2. Connect the upper positive and negative power terminals of the HV Box in rack 1 to the lower positive and negative power terminals of the HV Box in rack 2.
3. Repeat the same connection process from rack 2 to rack 3, and from rack 3 to rack 4.

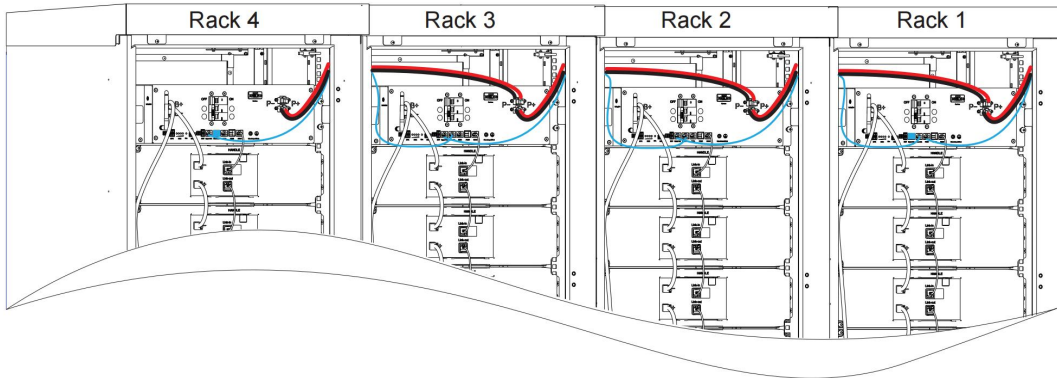

6 Operation and Commissioning

After the battery system is installed and connected, operate and commission it to check if it work properly

CAUTION

When operating the battery module, it is crucial to adhere to the following safety instructions:

- Technicians must undergo technical training and obtain certificates in accordance with local laws and regulations.
- Always stand on dry insulating objects and avoid wearing metal objects such as watches, rings, and necklaces during operation.
- Use insulating tools and wear appropriate protective equipment.
- Avoid contact with two charged positions with a potential difference to prevent electrical hazards.
- Display a prohibition sign to prevent people from approaching the equipment during operation.
- In case of any abnormality, immediately power off the battery module. Only proceed with further actions after identifying and confirming the causes of the abnormality.

By strictly following these safety instructions, technicians can minimize the risk of accidents and ensure a safe operating environment for the battery module.

6.1 Power on System

To power on the battery system after installation and cable connection, follow these steps:

1. Measure the voltage between P+ and P- using a multi-meter and ensure that the voltage output in the off mode is 0V.
2. Turn on the switch of the HV Box.
3. Input a voltage ranging from 100V to 500V at the P+/P- terminals, and the battery system will power on. Alternatively, you can input a 12V wakeup signal through the PCS1 port to power on the battery system.

Once the batteries are powered on, carefully observe their operation for 15 minutes to confirm that they can charge and discharge properly.

By following these steps, you can safely and effectively power on the battery system and ensure its proper functionality.

6.2 Power off System

Send a shutdown or relay off signal through PCS to power off the battery system.

WARNING

To power off the battery system, it is recommended to follow the proper procedure by turning off the breaker. Avoid cutting off the power directly as it may cause damage to the system. Only use this method when necessary. Swatten will not provide any warranty for damages caused by improper operations. It's crucial to handle the power-off process carefully to ensure the safety and integrity of the battery system.

7 Maintenance

Preparation

- Only professionals can conduct the battery maintenance.
- Prepare tools like safety gloves, cross head screwdriver and socket wrench.

7.1 Recharge Battery

Otherwise, improper power-off procedures may result in permanent damage to the battery module. In such cases, Swatten does not provide any warranty for any losses incurred. To ensure proper charging, set the charging parameters to "CV=56V, CC=10A," and charge the battery for two hours until the module terminal blocks measure a voltage ranging from 52.8V to 56V. Proper charging is essential to maintain the battery's performance and longevity.

7.2 Replace Battery

CAUTION

- Before installation, carefully inspect the new battery for any visible damages and ensure that all accessories are included in the package.
- Avoid changing the battery in rainy or stormy weather to prevent water damage or hazards.
- Ensure that the batteries are manufactured within one year and have a cycle difference less than 300 to ensure optimal performance.
- Make sure that the voltage difference between batteries in series does not exceed 1V. If the voltage difference is greater than 1V, charge the battery with the lower voltage until the voltage levels align with the requirement. This step is crucial to maintain the balance and efficiency of the battery system.

When encountering a faulty battery, replacement may be necessary. Follow these steps:

Step 1: Put on safety gloves.

Step 2: Issue a shutdown or relay off signal through PCS to deactivate the battery system.

Step 3: Turn the breaker switch of the HV box to OFF.

Step 4: Disconnect power cables and network cables from the battery terminals.

Step 5: Use a screwdriver to remove screws, then gently extract the battery from the rack.

Step 6: Using the handles, transfer the battery into a packaging case and transport it to the designated repair location.

Step 7: Install a new battery and connect the necessary cables.

Step 8: Switch the breaker of the HV box to ON. The battery system will power on.

7.3 Upgrade Firmware

The firmware of the battery system can be upgraded through USB, PCS, or Wi-Fi.

For details about how to upgrade the firmware, contact Swatten technical support.

7.4 Troubleshooting

PACK Status	PACK Information ★	Display Logic					Remark
		LED	LED	LED	LED	Bi-color LED5	
Remote		/	/	/	/	/	LED5 depending same as the normal status
Boot load		★	★	★	★	★	2Hz
Starting	Master / Slave	★	★	★	★	●	Master
		/	/	/	★	●	Slave 1
		/	/	★	/	●	Slave 2
		/	/	★	★	●	Slave 3
		/	★	/	/	●	Slave 4
		/	★	/	★	●	Slave 5
		/	★	★	/	●	Slave 6
		/	★	★	★	●	Slave 7
Application Mode checking	Parallel or single application mode checking success	SOC Display				★	Blink 5 times
	Waiting for power connection in parallel application	SOC Display				★	1Hz
Fault	Three - Level Over Voltage	/	/	/	●	●	
	Three - Level Under Voltage			●		●	
	Three - Level Over Temperature			●	●	●	
	Three - Level Under Temperature		●			●	
	Three - Level Over Current		●		●	●	
	Three - Level Under SOH		●	●		●	
	Internal communication		●	●	●	●	
	External communication	●				●	
	Parallel ID addressing failure	●			●	●	
	Series ID addressing failure	●		●		●	
	HV - BOX FUSE	●		●	●	●	
	Module FUSE	●	●			●	
	Contact failure	●	●		●	●	
	Insulation check fault	●	●	●		●	
BMS fault (internal fault such as relay failure)	●	●	●	●	●		
Shutdown	/	★	★	★	★	★ or ● or ●	LED5 depending on the previous status

● LED on

★ LED blink

8 Product Liability

Prior to utilizing the battery, it is essential to thoroughly review the specifications, safety guidelines, and operational instructions in order to understand its intended usage and scenarios.

Swatten disclaims any responsibility for accidents or liabilities resulting from the usage of the Product for applications or under conditions not outlined in this Document.

9 Recycle

Lithium-ion batteries are recyclable and contain valuable materials. They should be recycled in accordance with local laws and regulations. Please do NOT dispose of your battery in regular household waste.

For details on recycling used batteries, please reach out to the point of purchase or your battery distributor.

10 Regulation Compliance

10.1 UN 38.3

The battery has successfully passed UN38.3 (Section 38.3 of the seventh Revised Edition of the Recommendations on the Transport of Dangerous Goods: Manual of Tests and Criteria) and SN/T 0370.2-2009 (Part 2: Performance Test of the Rules for the Inspection of packaging for Exporting Dangerous Goods). It is categorized as class 9 dangerous goods and is approved for land and water transportation. However, air transport requires prior approval from the airline company.

- * Before transporting, ensure that the battery module is switched off.
- * During transportation, lay the battery flat; avoid standing or leaning it against surfaces to prevent potential impacts.
- * Maintain a temperature range of -20°C to +45°C during transit.
- * Avoid mixing the battery with explosive, flammable, or toxic substances.
- * Use van-type vehicles like containers or metallic vans; platform vehicles and convertibles are prohibited.
- * Do not stack foreign objects on top of the battery; stacking up to five batteries is acceptable.
- * Keep the original packaging intact and ensure labels remain visible and legible.
- * Shield from direct sunlight, rain, condensation, and mechanical damage.

11 Appendix

11.1 A Protection Policy

No.	Item	Unit	Level 1	Level 2	Level 3
			Warming	DC/DC Protection	Battery Protection
1	Protection voltage against over charge	V	3.6	3.65	3.7
2	Over charge protection delay	s	3	4	5
3	Protection voltage against over discharge	V	3.05	3	2.8
4	Over discharge protection delay	s	3	4	5
5	Cell "0V" Under-voltage Abnormal	V	/	/	2
6	Cell "0V" Under-voltage Abnormal delay	s	/	/	10
7	Protection value against over-charging and over-discharging current	A	57.75	60.38	61.95
8	Over current protection delay	s	3	4	5
9	Short-circuit protection value	A	/	/	400
10	Short-circuit protection delay	ms	/	/	150
11	Over temperature charging protection value	°C	50	55	56
12	Over-temperature discharging protection value	°C	50	55	56
13	Over-temperature protection delay	s	3	4	5
14	Low-temperature charging protection value	°C	-10	-12	-14
15	Low-temperature discharging protection value	°C	-10	-12	-14
16	Low-temperature discharging protection delay	s	3	4	5

11.2 Technical Data

Manufacturer	SieB-H-M Battery Energy Storage System-Home (HV)		
Product Type	SieB-H9800-M	SieB-H13K1-M	SieB-H16K3-M
Nominal Energy (kWh)*1	9.83	13.11	16.38
Usable Energy (kWh)*2	9.334	12.45	15.56
Module Type	SieB-H3277-M		
Module Parameter	51.2V64Ah 440*380*131mm 27kg		
Cell Type	LFP (LiFePO ₄)		
Nominal Capacity (Ah)	64		
Max. Module Configuration	3	4	5
Cell Configuration	1P48S	1P64S	1P80S
Nominal Voltage (V)	153.6	204.8	256
Operating Voltage Range (V)	144~172.8	192~230.4	240~288
Max. Continuous Current (A)*3	52.5		
Max. Continuous Power (kW)*3	7.56	10.08	12.60
Communication	CAN / RS485		
Parallel Connect	A maximum of 4 racks with CAN communication		
Weight (Kg)	176	206	236

Dimensions (W*D*H) (mm)		600*600*1500
Operating Temperature (°C)		-10~50
Storage Temperature (°C)		-30~60 (≤7 Days) / -20~45 (≤6 Months)
Humidity		5%~95%
Altitude (m)*3		≤2000
Enclosure Type		IP20 (Indoor)
Cooling		Natural convection
Installation Location		Floor-standing (In Cabinet)
Display		SOC indicator, Status indicator
Standard and Certification	Safety	IEC62619
	EMC	IEC61000-6-1/3
	Transportation	UN38.3
	Others	RoHS, REACH
Warranty*4		10Years
1. Test conditions: 2.5V~3.6V, 0.2C Charge (CC-CV) and Discharge at 25±3°C;		
2. Test conditions: 3.0V~3.6V, 0.2C Charge (CC-CV) and Discharge at 25±3°C;		
3. Max. Continuous Current / Power derating will occur related to Temperature / SOC / Humidity;		
4. Refer to Swatten SieB-H-M Limited Warranty Letter;		

Manufacturer	SieB-H-M Battery Energy Storage System-Home (HV)		
Product Type	SieB-H19K6-M	SieB-H22K9-M	SieB-H26K2-M
Nominal Energy (kWh)*1	19.66	22.94	26.21
Usable Energy (kWh)*2	18.67	21.79	24.89
Module Type	SieB-H3277-M		
Module Parameter	51.2V64Ah 440*380*131mm 27kg		
Cell Type	LFP (LiFePO ₄)		
Nominal Capacity (Ah)	64		
Max. Module Configuration	6	7	8
Cell Configuration	1P96S	1P112S	1P128S
Nominal Voltage (V)	307.2	358.4	409.6
Operating Voltage Range (V)	288~345.6	336~403.2	384~460.8
Max. Continuous Current (A)*3	52.5		
Max. Continuous Power (kW)*3	15.12	17.64	20.16
Communication	CAN / RS485		
Parallel Connect	A maximum of 4 racks with CAN communication		
Weight (Kg)	266	296	326
Dimensions (W*D*H) (mm)	600*600*1500		
Operating Temperature (°C)	-10~50		
Storage Temperature (°C)	-30~60 (≤7 Days) / -20~45 (≤6 Months)		
Humidity	5%~95%		
Altitude (m)*3	≤2000		
Enclosure Type	IP20 (Indoor)		
Cooling	Natural convection		

Installation Location		Floor-standing (In Cabinet)
Display		SOC indicator, Status indicator
Standard and Certification	Safety	IEC62619
	EMC	IEC61000-6-1/3
	Transportation	UN38.3
	Others	RoHS, REACH
Warranty*4		10Years
1. Test conditions: 2.5V~3.6V, 0.2C Charge (CC-CV) and Discharge at 25±3°C;		
2. Test conditions: 3.0V~3.6V, 0.2C Charge (CC-CV) and Discharge at 25±3°C;		
3. Max. Continuous Current / Power derating will occur related to Temperature / SOC / Humidity;		
4. Refer to Swatten SieB-H-M Limited Warranty Letter;		

All Rights Reserved

- **All Rights Reserved**

No part of this document can be reproduced in any form or by any means without the prior written permission of Shanghai Sieyuan Watten Technology Co., Ltd.(hereinafter "Swatten").

- **Trademarks**

Swatten and other Swatten trademarks used in this manual are owned by Swatten.

All other trademarks or registered trademarks mentioned in this manual are owned by their respective owners.

- **Software Licenses**

- It is prohibited to use data contained in firmware or software developed by Swatten, in part or in full, for commercial purposes by any means.
- It is prohibited to perform reverse engineering, cracking, or any other operations that compromise the original program design of the software developed by Swatten.

Shanghai Sieyuan Watten Technology Co., Ltd.

Address: No. 3399 Huaning Rd.
Minhang District,
Shanghai 201100
P. R. China

Website: <https://www.swatten.com>

About This Manual

The manual primarily encompasses product information, along with installation, operation, and maintenance guidelines.

It will refer to the device as the "inverter" unless otherwise specified.

- Target Audience

This manual is intended for professional technicians who have responsibilities for the installation, operation, and maintenance of inverters, as well as users who need to check inverter parameters.

Installation Requirements:

The installation of the inverter should only be carried out by professional technicians who meet the following requirements

- Possess knowledge of electronics, electrical wiring, and mechanical expertise, and be familiar with electrical and mechanical schematics.
- Have received professional training related to the installation and commissioning of electrical equipment.
- Capable of promptly responding to hazards or emergencies that may arise during the installation and commissioning process.
- Familiar with local standards and relevant safety regulations pertaining to electrical systems.
- Thoroughly read this manual and understand the safety instructions associated with the operations.

- How to Use This Manual

- Please carefully read this manual before utilizing the product and store it in a readily accessible location.
- All content, images, trademarks, and symbols in this manual are the property of Swatten. No part of this document may be reproduced by individuals not employed by Swatten without written authorization.
- The contents of this manual may be periodically updated or revised, and the specifications of the actual product purchased should take precedence.

- **Symbols**

This manual incorporates crucial safety instructions that are emphasized using specific symbols. These symbols are employed to ensure the safety of individuals and property during product usage or to assist in maximizing product performance efficiently..

It is essential to thoroughly comprehend the significance of the warning symbols to enhance your utilization of the manual.

DANGER

Indicates the presence of high-risk potential hazards that, if not avoided, could result in severe injury or even death.

WARNING

Indicates the presence of moderate-risk potential hazards that, if not avoided, could result in serious injury or even death.

CAUTION

Indicates the presence of low-risk potential hazards that, if not avoided, may lead to minor or moderate injury.

NOTICE

Indicates potential risks that, if not avoided, may result in device malfunctions or financial losses.

The "NOTE" designation is used to indicate supplementary information, emphasized content, or helpful tips that can assist you, such as problem-solving techniques or time-saving suggestions.

Change History

Changes between document issues are cumulative, meaning that each subsequent document issue includes all the changes made in earlier issues.

Issue 1 (2023-08-15)

This issue is the first official release.

Contents

1 Important Safety Information	1
1.1 Warning Label	1
1.2 Safety Precautions	3
2 Product Introduction	4
2.1 Product Features	4
2.2 Application Scenarios	4
2.3 Appearance and Terminals	5
2.4 Technical Parameters	8
3 What You Need	11
3.1 Installation and O&M Tools	11
3.2 Protective Equipment	11
4 Storage and Installation	12
4.1 Storage	12
4.2 Unpacking Inspection	12
4.3 Installation of Battery	12
4.3.1 Installation Requirements	12
4.3.2 Installation Process	13
5 Electrical Connection	15
5.1 Prepare Cables	16
5.2 Connect Cables	16
5.2.1 Wiring Within a Rack	17
5.2.2 Wiring Between Racks	18
6 Operation and Commissioning	20
6.1 Power on System	20
6.2 Power off System	20
7 Maintenance	21
7.1 Recharge Battery	21
7.2 Replace Battery	21
7.3 Upgrade Firmware	21
8 Product Liability	23
9 Recycle	24
10 Regulation Compliance	25
10.1 UN 38.3	25
11 Appendix	26
11.1 A Protection Policy	25
11.2 Technical Data	25

1 Important Safety Information

1.1 Warning Label



Do not dispose battery in household trash



Recyclable.



Certification in European Union area.



Risk of electric shock.



Explosive gas.



Battery may leak corrosive electrolyte.



Battery is heavy enough to cause severe injury.



Keep battery away from children.

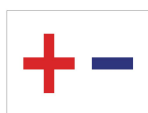

Do not reverse polarities.



Do not expose battery to flame.



Operate as specified by the manual.



Read the manual before operating.

Nameplate

Module

Swatten	
Lithium Ion Battery	
IFpP16/122/360/[16S]M/-10+50/90	
Model	SieB-H3277-M
Nominal Voltage	51.2V
Total/Rated Capacity	64Ah/62.4Ah
Total/Rated Energy	3.27kWh/3.19kWh
Ingress Protection	IP20
Operating Ambient Temperature	-10°C~50°C
Max. Short Current and Duration	1900A, 30ms
Operating Voltage Range	40V~57.6V
Max. Charge/Discharge Current	52.5A
Max. Charge/Discharge Power	2.52kW
Protection Class	I

Made in China

HVB Box

Swatten	
HV BOX	
HV BOX Model: SieB-H-M	
Operating Ambient Temperature: -10°C~50°C	
Ingress Protection: IP20	
Protection Class: I	
No. of Modules /Nominal Voltage/Energy/	
Input & Output Power	
<input type="checkbox"/>	3S/153.6VDC/9.06kWh/7.56kW
<input type="checkbox"/>	4S/204.8VDC/12.08kWh/10.08kW
<input type="checkbox"/>	5S/256.0VDC/15.10kWh/12.60kW
<input type="checkbox"/>	6S/307.2VDC/18.11kWh/15.12kW
<input type="checkbox"/>	7S/358.4VDC/21.13kWh/17.64kW
<input type="checkbox"/>	8S/409.6VDC/24.15kWh/20.16kW

Made in China

Label

WARNING AVERTISSEMENT

1. Do not disassemble or alter the battery in any way.
Ne démontez ni modifiez la batterie en aucune façon.
2. Do not use the battery for purposes not described in its documentation.
N'utilisez pas la batterie à des fins non décrites dans sa documentation.
3. Do not drop, strike, puncture, or step on the battery.
Ne laissez pas tomber, ne heurtez pas, ne percez pas et ne marchez pas sur la batterie.
4. In case of electrolyte leakage, keep leaked electrolyte away from contact with eyes or skin, immediately clean with water and seek help from a doctor.
En cas de fuite d'électrolyte, gardez l'électrolyte qui fuit loin du contact avec les yeux ou la peau, nettoyez immédiatement avec de l'eau et demander de l'aide à un médecin.
5. Do not put the battery into a fire. Do not use it or leave it in a place near fire, heaters, or high temperature sources.
Ne mettez pas la batterie au feu. Ne l'utilisez pas et ne le laissez pas dans un endroit près de feu, de radiateurs ou de sources de températures élevées.
6. Do not submerge the battery in water, or expose it to moisture.
Ne plongez pas la batterie dans l'eau et ne l'exposez pas à l'humidité.
7. Do not allow the terminals to contact exposed wire or metal.
Ne laissez pas les bornes entrer en contact avec du fil ou du métal exposé.
8. The battery is heavy and can cause injury if not handled safely.
La batterie est lourde et peut provoquer des blessures si elle n'est pas manipulée en toute sécurité.
9. Keep out of reach of children or animals. Tenir hors de portée des enfants ou des animaux.

1.2 Safety Precautions

Risks of Electrolyte Leakage:

- Avoid subjecting the battery to strong impacts or crushing/puncturing it.
- Prevent the battery from falling, and if it does, turn it off immediately and stop using it.
- Do not open or mutilate batteries, as the released electrolyte is harmful to the skin and eyes.

Risks of Fire:

- Keep the battery away from direct sunlight.
- Avoid contact with conductive objects like wires.
- Ensure the battery is away from fire sources, inflammable, explosive, and chemical materials.
- Never dispose of batteries in a fire.

Risks of Electric Shock:

- Do not touch the battery with wet hands.
- Keep the battery out of reach of children and animals.
- High short-circuited current in a battery can cause electric shock and burns.
- Battery installation and wire connections should only be handled by professionals.

Risks of Damage:

- Keep a distance from water sources to prevent damage to the battery.
- Avoid exposing the battery to high voltage.
- Place the battery on a flat surface and avoid placing any foreign objects or stepping on it.
- Ensure battery-connected PCS (Power Control System) has reinforced insulation.

Table 1-1 Responses to Emergencies

Event	Description and Recommended Actions
Leakage	<ul style="list-style-type: none"> • Inhalation: Immediately leave the contaminated area. • Swallowing: Induce vomiting. • Contact with Eyes: Flush eyes with flowing water for 15 minutes. • Contact with Skin: Thoroughly wash affected area with soap and water. • After taking emergency measures, seek immediate medical attention.
Fire	<p>In case of heating above 150°C, take immediate following action to prevent the battery from catching fire:</p> <ul style="list-style-type: none"> • Use ABC or carbon dioxide extinguisher to extinguish any small fires before they escalate. • If the fire is uncontrollable, promptly evacuate people to a safe location before seeking assistance from professional fire protection personnel. • Ensure personal safety is a priority while dealing with fire incidents involving the battery.
Wet battery	If the battery becomes wet or has been submerged in water, avoid handling it. Contact your distributor immediately for technical assistance.
Damage	A damaged battery is hazardous and should be handled with extreme caution. It must not be used anymore as it could pose a safety risk to people and property. If you suspect the battery is damaged, cease all operations and promptly return it to the distributor.

2 Product Introduction

The 64Ah HV battery system is designed for residential energy storage and consists of battery modules as the primary power supply unit and the HV Box as the battery management unit. The battery module is built using 64Ah cells arranged in 1 parallel and 16 series configuration.

2.1 Product Features

Compared to regular batteries, the battery system exhibits superior charging and discharging performance, an extended cycle life, and reduced self-discharge loss. It allows up to 8 battery modules to be connected in series, expanding the energy and power capacity of the energy storage system. Communication with the PCS is facilitated through CAN or RS485 network ports. The HV Box oversees battery operation and issues timely alarms to prevent any operation exceeding the limits.

- **Monitoring**
Monitors cell voltage, cell temperature, battery voltage, and current.
- **SOC Estimate**
Provides accurate estimation of the remaining electricity volume.
- **Alarm**
Triggers an alarm in case of overvoltage, undervoltage, overcurrent, over temperature, or under temperature.
- **Protection**
Offers protection against overvoltage, undervoltage, overcurrent, over temperature, under temperature, cell fault, and hardware failure.
- **Report**
Sends alarm messages and operation data to PCS via CAN or RS485 network ports.
- **Series Connection**
Supports up to 8 battery modules in series connection.
- **Fault-triggered Power-off**
The battery powers off in the event of level three undervoltage, 0V cell, or series connection failure.
- **Forced Power-off**
When the battery system is not connected to the mains supply, turning OFF the breaker switch on the HV Box powers off the battery modules.
- **Activation**
By applying 100V to 500V through the P+/P- terminals, the battery can be activated from off mode to standby status.

2.2 Application Scenarios

The battery system collaborates with PCS (Power Control System) and loads in the residential energy storage system. It functions by storing energy generated by a photovoltaic system (PV) or obtained from the grid. The stored energy is then utilized to provide power when the PV system is not generating or the grid supply is unavailable.

Figure 2-1 Application Scenario

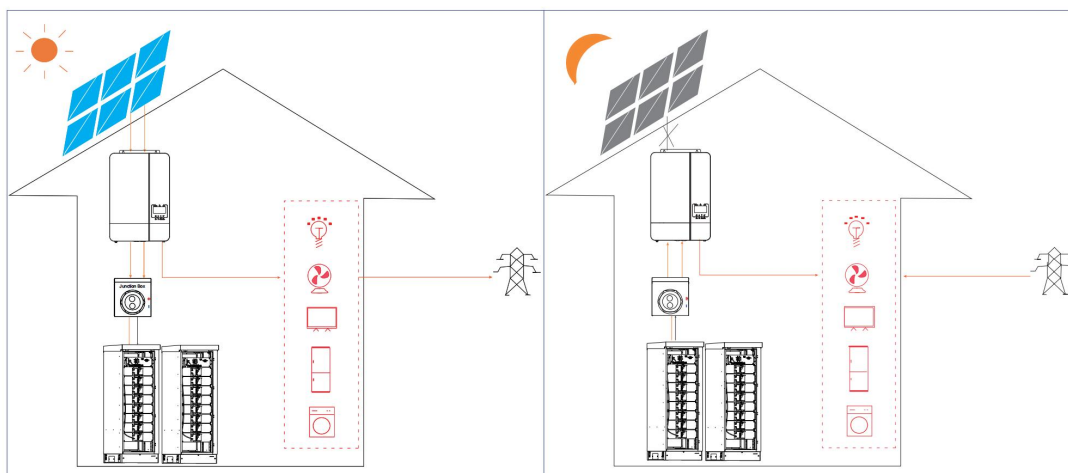

The PV system optimizes energy for loads, and excess energy charges the battery before exporting to the grid.

Battery powers nighttime loads when PV is unavailable. If battery energy is insufficient, it supplements loads with grid power.

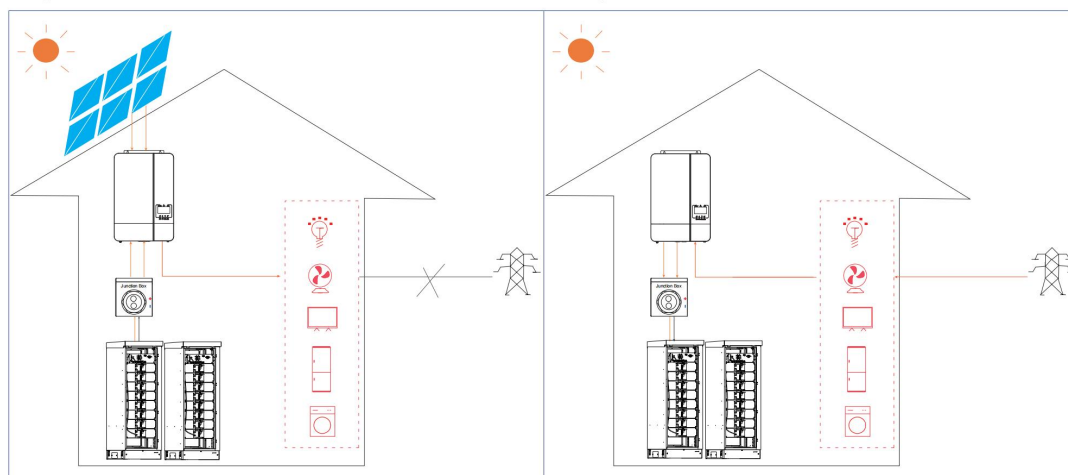

During grid outages, loads can be powered by the battery and PV system.

Battery can be charged using grid power. It is advisable for users to store energy from the grid to the battery during periods of lower electricity prices.

2.3 Appearance and Terminals

The battery system is composed of battery modules and HV box.

Table 2-1 Mechanical features

Parameter	Module	HV Box
Dimension	W445*D377*H131mm	W400*D188*H131mm
Weight	27.5kg (for reference only)	6kg (for reference only)
Installation	Rack-mounted installation	Rack-mounted installation

Figure 2-2 HV Box

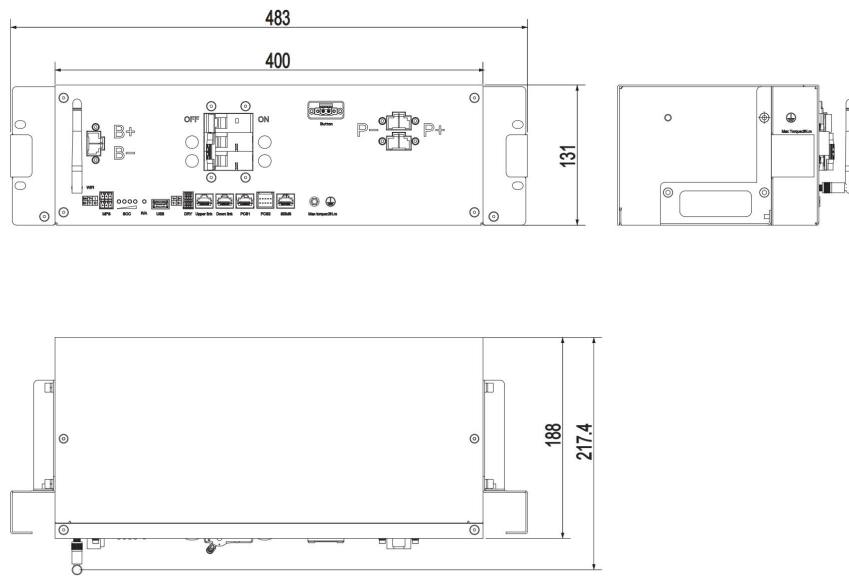

Figure 2-3 Module

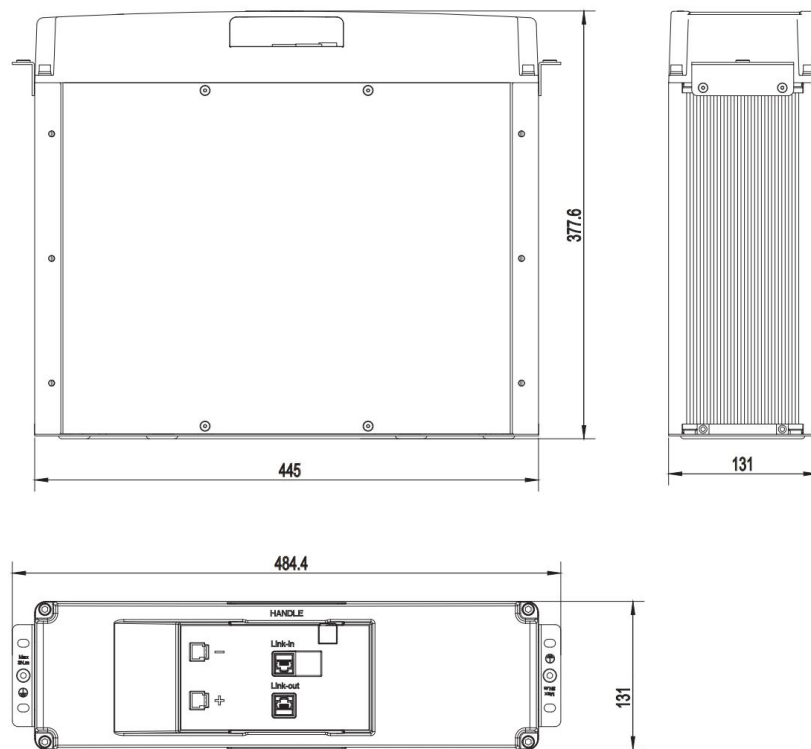

Figure 2-4 HV Box panel

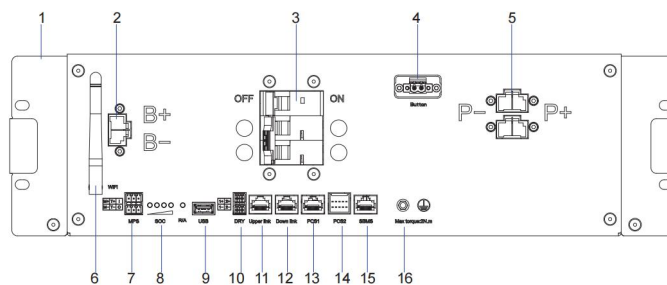



Table 2-2 Ports and terminals

No.	Label	Description
1	Bracket	To fix the HV Box to a rack
2	B+/B-	Positive and negative input port
3	ON/OFF	Breaker switch
4	Button	Start button interface
5	P+/P-	Positive and negative output port between battery system and PCS
6	WiFi	Wi-Fi antenna
7	MPS port	Maintenance power supply, external environment sampling, door access sensor
8	LED indicators	SOC: Indicating the battery SOC R/A: Indicating the running status and faults
9	USB	Software upgrade and history data export port
10	DRY	Output Dry interface
11	Upper link	Input port for parallel connection
12	Down link	Output port for parallel connection
13	PCS1	RJ45 PCS communication port
14	PCS2	JST PCS communication port
15	SBMS	Module communication port
16		Grounding terminal

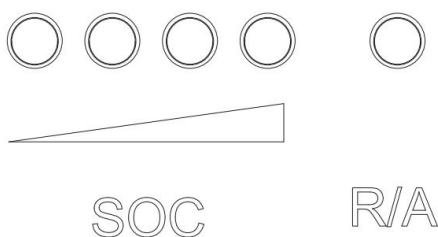

Table 2-3 LED indicators

PACK Status	PACK Information	Display Logic				Bi-color	Remark
		LED1	LED2	LED3	LED4	LED5	
Charging	0%-25.0% SOC	■				●	Flash LED (water light), 1Hz
	25.1%-50.0% SOC	■	■			●	Flash LED (water light), 1Hz
	50.1%-75.0% SOC	■	■	■		●	Flash LED (water light), 1Hz
	75.1%-99.9% SOC	■	■	■	■	●	Flash LED (water light), 1Hz
	100% SOC	●	●	●	●	●	
Discharging & Standby	100%-75.1%	●	●	●	●	●	
	75.0%-50.1%	●	●	●		●	
	50.0%-25.1%	●	●			●	
	25.0%-0%	●				●	

■ LED flash

● LED on

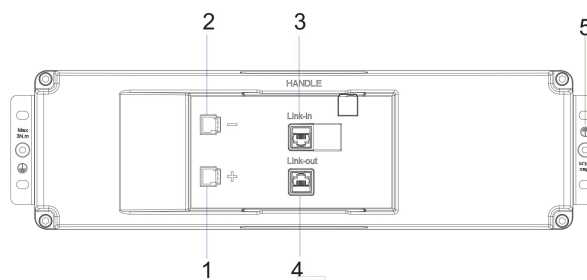

Table 2-4 Ports and terminals of module

No.	Label	Description
1	+	Positive output of module
2	-	Negative output of module
3	Link-out	Communication output of series connection
4	Link-in	Communication input of series connection
5		Grounding terminal

2.4 Technical Parameters

No.	Parameter	Value
1	Total capacity	64Ah
2	Rated/Usable capacity	58.97Ah ¹
3	Max. charge current	-10°C≤T≤0°C, 10.6A 0°C≤T≤5°C, 16A 5°C≤T≤15°C, 32A 15°C≤T≤45°C, 52.5A 45°C≤T≤50°C, 32A 50°C≤T≤55°C, 16A
4	Max. discharge current	-10°C≤T≤0°C, 10.6A 0°C≤T≤45°C, 52.5A 45°C≤T≤50°C, 42.6A 50°C≤T≤55°C, 16A
5	Peak charge/discharge current (5S)	61.95A
6	Room Temperature Calendar Life (25°C±2°C)	≥15 years (warranty)
7	Room Temperature Cycle Life (25°C±2°C)	≥6000 cycles/ 60%EOL
8	Operating ambient temperature	-10°C ~50°C
9	Optimal operating temperature	15°C ~30°C
10	Operating ambient humidity	5%~95%
11	RTE	≥95%
12	Discharge rate of Module	≤1.5%/month/@25°C
13	Module Series connection	3S~8S
14	Rack Parallel connection	4 units in parallel
15	Cooling	Natural cooling
16	Altitude	≤2000m
17	Communication port (with module)	CAN (one port)
18	Communication port (between battery systems)	CAN (two ports)

19	Communication between PCS and battery system	CAN/RS485 (one port)
20	Regulation compliance	IEC62619/JISC8715-2
21	Certification	/
22	EMC standard	EN61000-6-1 &EN61000-6-3
23	UN Transportation Test Standard	UN38.3
24	Ingress Protection	IP55
25	Environment protection standard	RoHS, REACH

Table 2-5 Electrical Parameters

Parameter	Specifications					
	3S	4S	5S	6S	7S	8S
Total energy (kWh)	9.83	13.11	16.38	19.66	22.94	26.21
Rated/Usable energy (kWh)	9.06	12.08	15.10	18.11	21.13	24.15
Nominal voltage (V)	153.6	204.8	256	307.2	358.4	409.6
Output voltage range (V)	144~172.8	192~230.4	240~288	288~345.6	336~403.2	384~460.8
Max. charge/discharge power (kW)	7.56	10.08	12.6	15.12	17.64	20.16
Peak charge/ discharge power (kW) (@25°C , 5S)	10.26	13.68	17.1	20.52	23.94	27.36

Table 2-6 Module specifications

No.	Items	Specifications
1	Total Capacity / Energy	64Ah/3.27kWh
2	Rated/Usable Capacity/Energy	58.97Ah/3.02kWh2
3	Nominal Voltage	51.2V
4	Output Voltage Range	40V~57.6V
5	Shipment Voltage	52.16V~53.04V
6	Module Safety Certification	JISC8715-1&2/ JISC6950-1
7	Cell Safety Certification	IEC62619/UL1973
8	UN Transportation Test Standard	UN38.3
9	Storage conditions	-30°C to 60°C /7days; -20°C to 45°C/6months, 95%RH
10	Ingress Protection	IP20
11	Altitude	≤2000m
12	Series Connection	Series connection voltage difference among modules $\Delta V \leq 1V$
13	Connection	16S1P
14	Shipment Capacity	30% SOC (voltage ranging between 3.292V±10mV)

Table 2-7 HV Box specifications

No.	Items	Specifications
1	Max. operating voltage range	96V~460.8V
2	Max. input/output current	52.5A
3	Peak input/output current (5S)	61.95A
4	Optimal operating temperature	15°C ~30°C
5	Environment temperature range	-10°C ~50°C
6	Communication Port between HV Box and Module	CAN2.0
7	Communication Port between HV Box and PCS or DC/DC	RS485
8	Max. Module Series Connections	8S
9	Ingress Protection	IP20

3 What You Need

3.1 Installation and O&M Tools

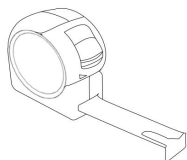

Tape measure



Screwdriver

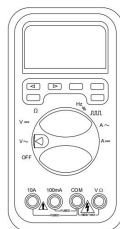

Multi-meter



Mark pencil

3.2 Protective Equipment



Insulated gloves



Safety goggles



Rubber boots

To prevent injury, always wear acid-resistant clothing, PVC gloves, goggles and rubber boots.

4 Storage and Installation

4.1 Storage

Battery storage life

Life	Temperature	Humidity
7 days	-30°C to -20°C or 45°C to 60°C	5%RH-95%RH
180 days	-20°C to 45°C	5%RH-95%RH

- If the battery is not used for more than 1 week, store it following the specified storage conditions.
- Position the battery according to the labeling on the packaging and avoid placing it upside down.
- Store batteries in a shaded and rain-free location.
- Maintain a minimum distance of two meters between the batteries and any heat source (e.g., radiator).
- Avoid exposure to corrosive substances and organic materials, including gases.
- Separate batteries with defects from normal ones by using walls or placing them in different fire protection zones.
- Ensure the storage area is dry, clean, and well-ventilated.
- Recharge batteries that have been stored for more than 6 months.
- Set the charging parameters to "CV=56V, CC=10A" and charge the battery for two hours until the terminal blocks measure between 52.8V and 56V.

4.2 Unpacking Inspection

Thoroughly examine the package for any signs of damage, such as holes, cracks, or other marks. If any package damages are noticed, refrain from opening it and promptly inform your distributor.

Once the package is opened, carefully inspect the battery for any damages, including cracks, dents, punctures, deformations, acid leaks, or any visible abnormalities. Also, ensure that all accessories listed in the packing list are present. If any part is missing or damaged, please notify your distributor.

For a detailed list of packing items, refer to the packing list provided in the carton box.

4.3 Installation of Battery

CAUTION

Avoid direct exposure of the battery to sunlight or rain.

Maintain a low level of dirt or dust around the battery.

Avoid installing the battery in areas prone to frequent flooding.

Avoid installation in highly humid environments.

Do not stack batteries during installation.

Ensure that the battery system is installed within its specified operation requirements for environmental conditions.

Ensure there is direct contact between the battery shell and ambient air, and refrain from covering or shielding the battery.

4.3.1 Installation Requirements

To ensure proper installation, it is advised to place the battery system indoors within a rack. However, if you choose to install it outdoors, make sure to select a rack with a suitable IP rating for outdoor use. Additionally, construct a sunshade and rain shelter to protect the battery from direct sunlight and rain exposure. This will help maintain the longevity and performance of the battery system.

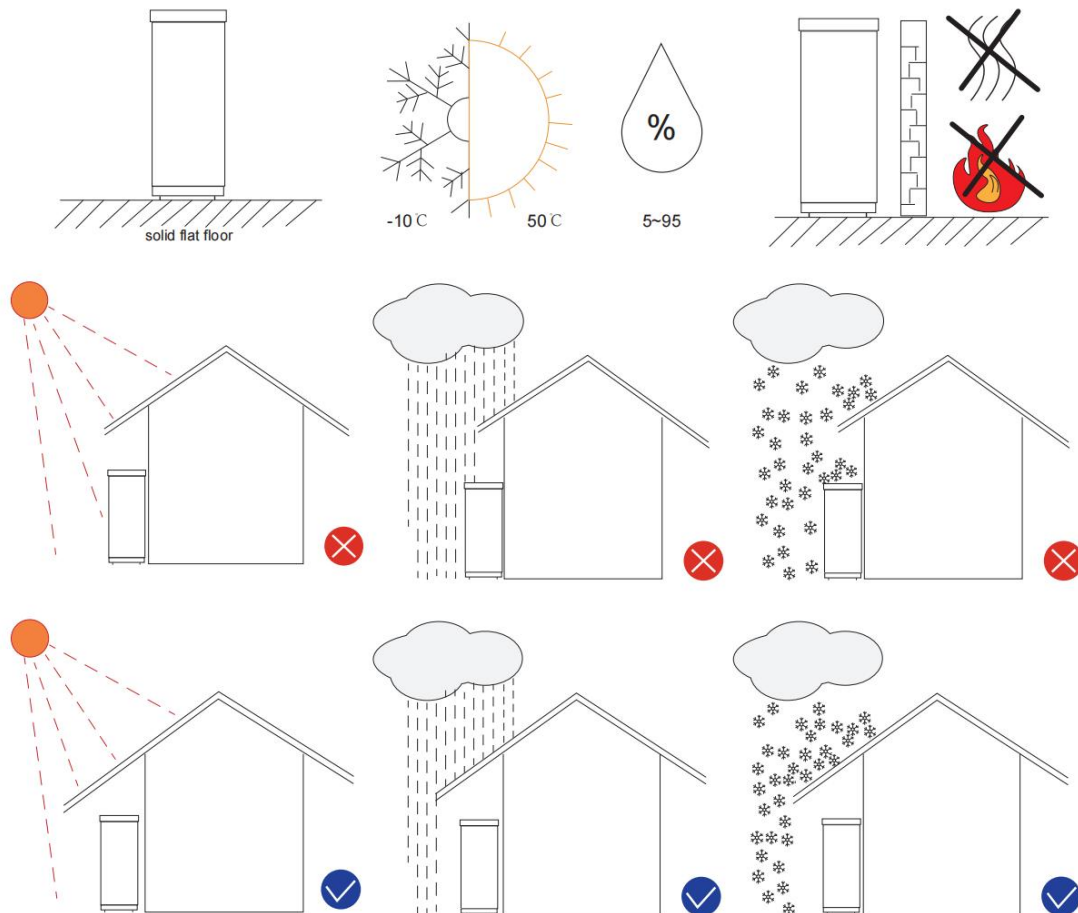

4.3.2 Installation Process

CAUTION

Installers should be well-trained and hold the necessary qualification certificates as required by local regulations.

Ensure that all switches of the HV Box are in the off position before proceeding with the installation.

Prior to installing the battery, ensure the use of safety goggles, insulation gloves, and safety shoes for personal protection. Remove any conductive accessories like watches, bracelets, and rings.

The weight of each battery is approximately 27.5 kg, and each HV Box weighs around 6 kg. Before installation, verify that the chosen rack can safely support the total weight.

Take note of the dimensions of the battery (W445D377H131 mm) and the HV Box (W400D188H131 mm).

Ensure that the rack has sufficient volume to accommodate these components.

To enhance the battery life, it is recommended to leave a gap greater than 3 mm between batteries to facilitate cooling.

Ensure the battery is powered off before starting any installation procedure. It is advisable to have assistance during the installation process.

Step 1: Turn off the HV Box by pulling the breaker switch to the OFF position.

Step 2: Carefully insert the battery modules into the rack and securely fasten them to the cabinet using screws, following the illustration provided.

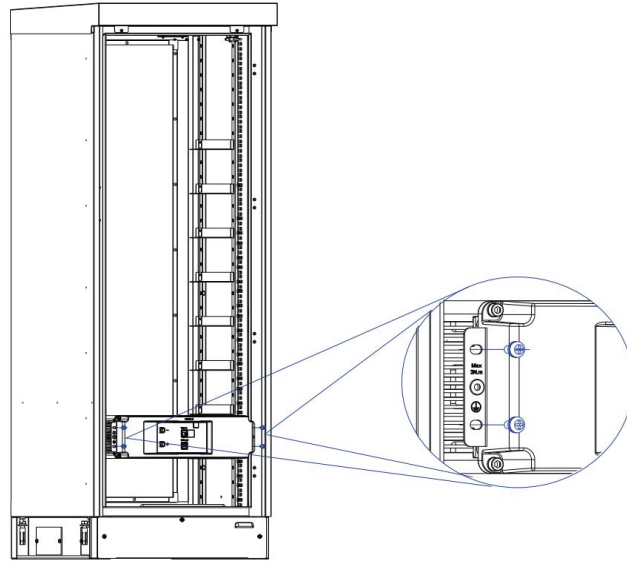

Step 3 Push the HV box into the rack and fasten it with screws

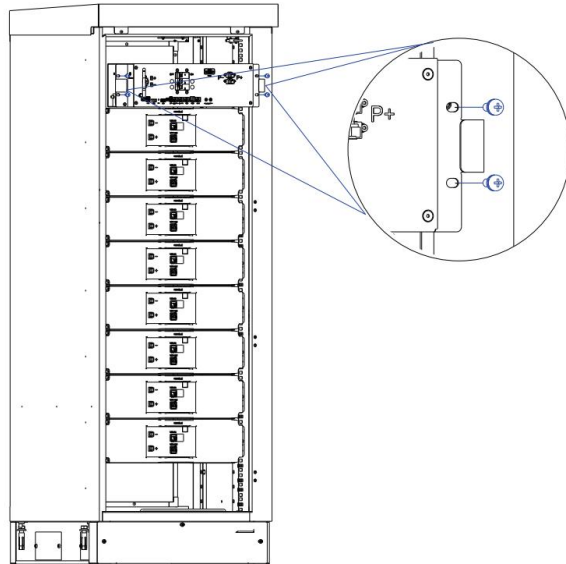

5 Electrical Connection

The HV Box and module provide the following network ports and power terminals for electrical connection.

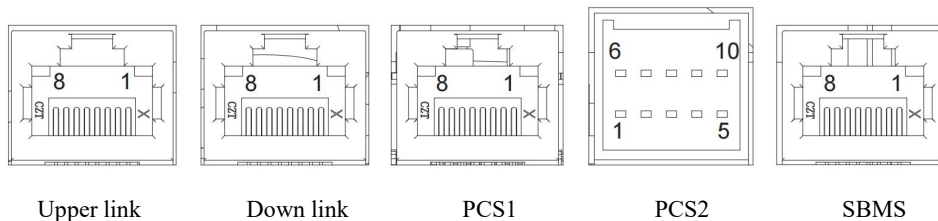

No.	Upper link	Down link	PCS1	PCS2	SBMS
1	CANH	CANH	PCS_485_B	Shut Down	CANH
2	CANL	CANL	PCS_485_A	Alarm	CANL
3	ID_IN	ID_OUT	Dry1+	PCS-RS485+A	FAULT
4	GND_C	GND_C	PCS_CANH	GND	S_POW-12V
5	Master address	Slave address	PCS_CANL	12V-Power	S_POW-12V
6	Dry-	Dry-	Dry-	PCS_CANH	ID_OUT
7	Dry+	Dry+	PCS_12V	PCS_CANL	GND_S
8	12V IN	12V OUT	PCS_GND	PCS-RS485-B	GND_S
9				Dry+	
10				GND	

Table 5-1 Module ports

No.	Link IN	Link OUT
1	CANH	CANH
2	CANL	CANL
3	FAULT	FAULT
4	S_POW-12V	S_POW-12V
5	S_POW-12V	S_POW-12V
6	ID_IN	ID_OUT
7	GND_S	GND_S
8	GND_S	GND_S



Figure 5-2 Power ports

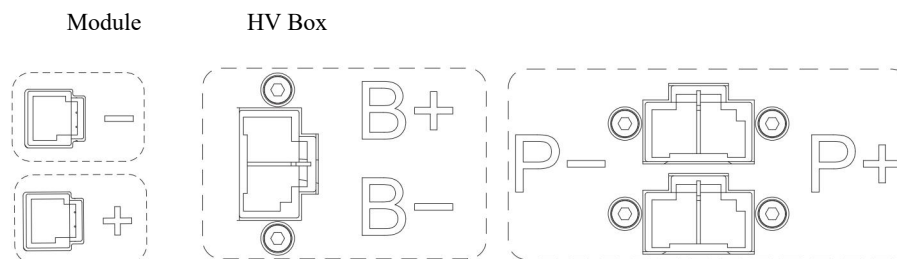

5.1 Prepare Cables

Swatten provides the following cables and wires for the electrical connection of 4 or 8 modules in series and one HV Box within a rack.

Table 5-2 Cable set for series connection

No.	Cable Name	4 Series	8 Series	Description	Remarks
1	Power cable A	1pcs	1pcs	Power cable between HVB and modules	he cable lengthes for 4 series and 8 series are different
2	Power cable B	3 pcs	7pcs	Power cable between modules in series connection	
3	Network cable	4pcs	8pcs	Communication cable between HV Box and module	

For other connections, you need to prepare wires and cables according to the connector specifications.

No.	Port/Terminal	Connector	Model Connector Type	Cable Cross-Section
1		HVB front panel	M4	8AWG
2		HVB side panel	M5	8AWG
3		Module hanger	M6	8AWG
4	Upper Link	CZT, 10221188F176	RJ45	AWG24x8
5	Down Link	CZT, 10221188F176	RJ45	AWG24x8
6	SBMS	CZT, 10221188F176	RJ45	AWG24x8
7	PCS1	CZT, 10221188F176	RJ45	AWG24x8
8	P+/P-	HRS, DF60-2EP-10.16C	CONN PLUG 10.16MM 2POS	8AWG
9	PCS2	JST, S10B-J21DK-GGXR	Crimp Style Connector (Wire-to-Board Style), 2.5 mm pitch, 10 positions, double row	(AWG28 to AWG20) x10
10	DRY	AMPHENOL, KE041151A000G	TERM BLOCK HDR 4POS 90DEG 3.5MM	AWG20x4
11	MPS	AMPHENOL, KE061151A000G	TERM BLOCK HDR 6POS 90DEG 3.5MM	AWG20x6

5.2 Connect Cables

The battery system allows customers to customize applications. Three to eight battery modules can be installed and connected in series within one rack and a maximum of four racks can be connected in parallel. This section describes how to wire modules and racks. Eight modules in series and four racks in parallel are describes as examples.

CAUTION

- Before performing any operations on batteries, ensure that all batteries and electrical units are powered off to avoid any risk of electric shock or injury.
- Always wear appropriate protective equipment, such as safety gloves and safety goggles, when handling batteries to protect yourself from potential hazards.
- After wiring the batteries, carefully inspect the cables to ensure that they are not twisted or tangled, as

this could lead to improper connections and potential issues.

- Verify that the batteries are manufactured within one year and have a cycle difference of less than 300 to ensure optimal performance and reliability.

5.2.1 Wiring Within a Rack

Wire modules and the HV box in the following process:

Step 1 Connect the grounding terminals on HV Box and modules to the grounding terminal of the rack and ground the rack.

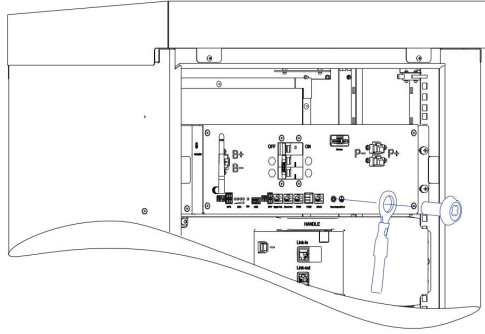

CAUTION

Please be aware that Swatten does not include the grounding wires required for this installation. It is your responsibility to select and provide the appropriate grounding wires based on the terminal specifications provided in this document.

Both the HV Box and modules have two grounding terminals each. You can choose one of the grounding terminals to ground both the HV Box and modules. Ensure that the selected grounding wire meets the necessary requirements and standards for a safe and reliable installation.

Step 2: Connect Network Cables

1. Use a network cable to establish a connection between the Link-in port of Module 1 and the SMBS port of the HV Box.
2. Insert one end of another network cable into the Link-out port of Module 1 and the other end into the Link-in port of Module 2.
3. Continue connecting Module 2 to Module 8 in the same manner.
4. If only one rack is being used, insert a crystal plug with pin 4 and pin 5 short-circuited into the Upper Link and Down Link ports of the HV Box, respectively.

Step 3: Connect Power Cables

1. Use a power cable to link one pair of HVB Box P+ and P- terminals to the +/- terminals of the PCS.
2. Utilize power cable A to connect the - terminal of Module 1 and the + terminal of the last module to the B-/B+ terminal of the HV Box.
3. Use power cable C to connect the + terminal of Module 1 to the - terminal of Module 2.
4. Continue connecting each subsequent module in a similar manner until reaching the last module.

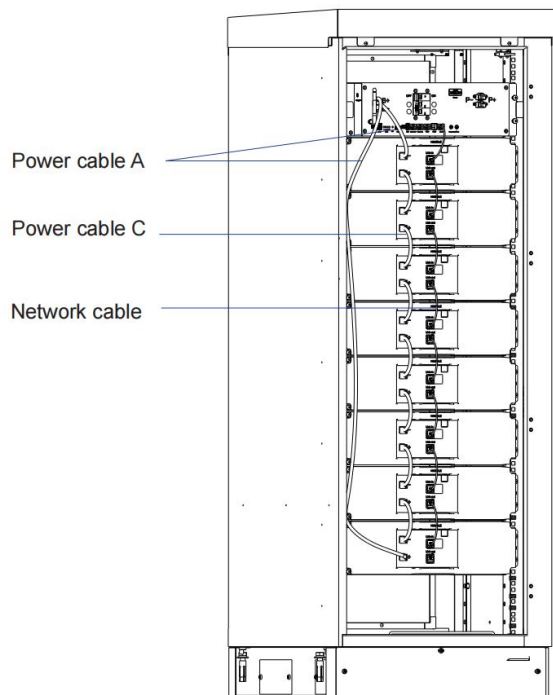

CAUTION

The HV Box offers two pairs of P+/P- terminals, and you have the flexibility to choose either one to connect to the PCS.

It is crucial to ensure the correct connection of the positive and negative terminals of the modules, HV Box, and PCS to avoid potential short circuits and prevent damage to the battery system.

5.2.2 Wiring Between Racks

Once the internal cable wiring within the racks is complete, you can proceed to parallelly connect up to 4 racks. Refer to the provided figures, where rack 1 to rack 4 should be connected sequentially from right to left. Follow these steps to wire the racks accordingly:

CAUTION

Please be aware that Swatten does not supply the wires or cables required for parallel connection of racks.

Step 1: Establish network connections between racks.

1. Place a crystal plug with pins 4 and 5 short-circuited into the Upper link port of the HV Box located in rack 1.
2. Connect the PCS1 port of the HV Box in rack 1 to the PCS.
3. Link the Down link port of the HV Box in rack 1 to the Upper link port of the HV Box in rack 2.
4. Repeat the same linking process from rack 2 to rack 3, and from rack 3 to rack 4.
5. Insert a crystal plug with pins 4 and 5 short-circuited into the Down link port of the HV Box in rack 4.

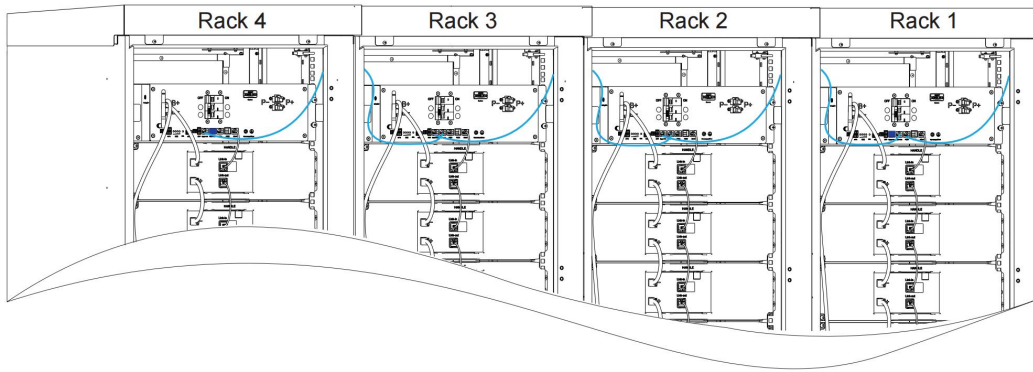

Step 2: Establish power connections between the racks.

1. Link the lower positive and negative power terminals of the HV Box in rack 1 to the power terminals of the PCS.
2. Connect the upper positive and negative power terminals of the HV Box in rack 1 to the lower positive and negative power terminals of the HV Box in rack 2.
3. Repeat the same connection process from rack 2 to rack 3, and from rack 3 to rack 4.

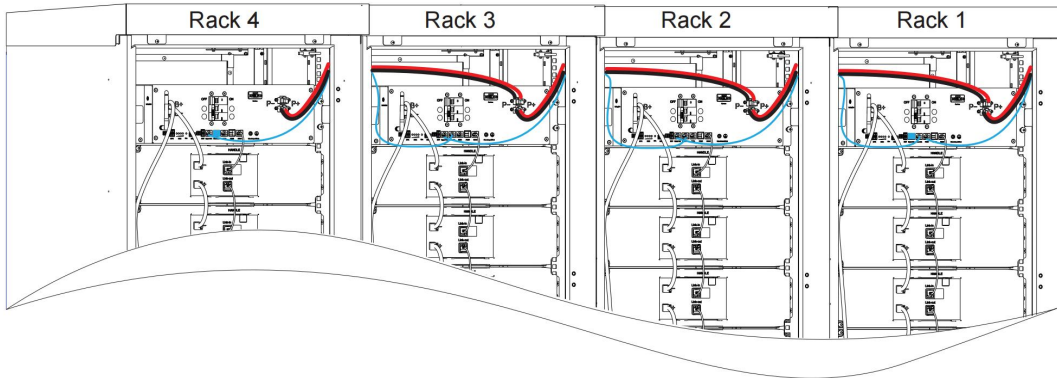

6 Operation and Commissioning

After the battery system is installed and connected, operate and commission it to check if it work properly

CAUTION

When operating the battery module, it is crucial to adhere to the following safety instructions:

- Technicians must undergo technical training and obtain certificates in accordance with local laws and regulations.
- Always stand on dry insulating objects and avoid wearing metal objects such as watches, rings, and necklaces during operation.
- Use insulating tools and wear appropriate protective equipment.
- Avoid contact with two charged positions with a potential difference to prevent electrical hazards.
- Display a prohibition sign to prevent people from approaching the equipment during operation.
- In case of any abnormality, immediately power off the battery module. Only proceed with further actions after identifying and confirming the causes of the abnormality.

By strictly following these safety instructions, technicians can minimize the risk of accidents and ensure a safe operating environment for the battery module.

6.1 Power on System

To power on the battery system after installation and cable connection, follow these steps:

1. Measure the voltage between P+ and P- using a multi-meter and ensure that the voltage output in the off mode is 0V.
2. Turn on the switch of the HV Box.
3. Input a voltage ranging from 100V to 500V at the P+/P- terminals, and the battery system will power on. Alternatively, you can input a 12V wakeup signal through the PCS1 port to power on the battery system.

Once the batteries are powered on, carefully observe their operation for 15 minutes to confirm that they can charge and discharge properly.

By following these steps, you can safely and effectively power on the battery system and ensure its proper functionality.

6.2 Power off System

Send a shutdown or relay off signal through PCS to power off the battery system.

WARNING

To power off the battery system, it is recommended to follow the proper procedure by turning off the breaker. Avoid cutting off the power directly as it may cause damage to the system. Only use this method when necessary. Swatten will not provide any warranty for damages caused by improper operations. It's crucial to handle the power-off process carefully to ensure the safety and integrity of the battery system.

7 Maintenance

Preparation

- Only professionals can conduct the battery maintenance.
- Prepare tools like safety gloves, cross head screwdriver and socket wrench.

7.1 Recharge Battery

Otherwise, improper power-off procedures may result in permanent damage to the battery module. In such cases, Swatten does not provide any warranty for any losses incurred. To ensure proper charging, set the charging parameters to "CV=56V, CC=10A," and charge the battery for two hours until the module terminal blocks measure a voltage ranging from 52.8V to 56V. Proper charging is essential to maintain the battery's performance and longevity.

7.2 Replace Battery

CAUTION

- Before installation, carefully inspect the new battery for any visible damages and ensure that all accessories are included in the package.
- Avoid changing the battery in rainy or stormy weather to prevent water damage or hazards.
- Ensure that the batteries are manufactured within one year and have a cycle difference less than 300 to ensure optimal performance.
- Make sure that the voltage difference between batteries in series does not exceed 1V. If the voltage difference is greater than 1V, charge the battery with the lower voltage until the voltage levels align with the requirement. This step is crucial to maintain the balance and efficiency of the battery system.

When encountering a faulty battery, replacement may be necessary. Follow these steps:

Step 1: Put on safety gloves.

Step 2: Issue a shutdown or relay off signal through PCS to deactivate the battery system.

Step 3: Turn the breaker switch of the HV box to OFF.

Step 4: Disconnect power cables and network cables from the battery terminals.

Step 5: Use a screwdriver to remove screws, then gently extract the battery from the rack.

Step 6: Using the handles, transfer the battery into a packaging case and transport it to the designated repair location.

Step 7: Install a new battery and connect the necessary cables.

Step 8: Switch the breaker of the HV box to ON. The battery system will power on.

7.3 Upgrade Firmware

The firmware of the battery system can be upgraded through USB, PCS, or Wi-Fi.

For details about how to upgrade the firmware, contact Swatten technical support.

7.4 Troubleshooting

PACK Status	PACK Information ★	Display Logic					Remark
		LED	LED	LED	LED	Bi-color LED5	
Remote		/	/	/	/	/	LED5 depending same as the normal status
Boot load		★	★	★	★	★	2Hz
Starting	Master / Slave	★	★	★	★	●	Master
		/	/	/	★	●	Slave 1
		/	/	★	/	●	Slave 2
		/	/	★	★	●	Slave 3
		/	★	/	/	●	Slave 4
		/	★	/	★	●	Slave 5
		/	★	★	/	●	Slave 6
		/	★	★	★	●	Slave 7
Application Mode checking	Parallel or single application mode checking success	SOC Display				★	Blink 5 times
	Waiting for power connection in parallel application	SOC Display				★	1Hz
Fault	Three - Level Over Voltage	/	/	/	●	●	
	Three - Level Under Voltage			●		●	
	Three - Level Over Temperature			●	●	●	
	Three - Level Under Temperature		●			●	
	Three - Level Over Current		●		●	●	
	Three - Level Under SOH		●	●		●	
	Internal communication		●	●	●	●	
	External communication	●				●	
	Parallel ID addressing failure	●			●	●	
	Series ID addressing failure	●		●		●	
	HV - BOX FUSE	●		●	●	●	
	Module FUSE	●	●			●	
	Contact failure	●	●		●	●	
	Insulation check fault	●	●	●		●	
BMS fault (internal fault such as relay failure)	●	●	●	●	●		
Shutdown	/	★	★	★	★	★ or ● or ●	LED5 depending on the previous status

● LED on

★ LED blink

8 Product Liability

Prior to utilizing the battery, it is essential to thoroughly review the specifications, safety guidelines, and operational instructions in order to understand its intended usage and scenarios.

Swatten disclaims any responsibility for accidents or liabilities resulting from the usage of the Product for applications or under conditions not outlined in this Document.

9 Recycle

Lithium-ion batteries are recyclable and contain valuable materials. They should be recycled in accordance with local laws and regulations. Please do NOT dispose of your battery in regular household waste.

For details on recycling used batteries, please reach out to the point of purchase or your battery distributor.

10 Regulation Compliance

10.1 UN 38.3

The battery has successfully passed UN38.3 (Section 38.3 of the seventh Revised Edition of the Recommendations on the Transport of Dangerous Goods: Manual of Tests and Criteria) and SN/T 0370.2-2009 (Part 2: Performance Test of the Rules for the Inspection of packaging for Exporting Dangerous Goods). It is categorized as class 9 dangerous goods and is approved for land and water transportation. However, air transport requires prior approval from the airline company.

- * Before transporting, ensure that the battery module is switched off.
- * During transportation, lay the battery flat; avoid standing or leaning it against surfaces to prevent potential impacts.
- * Maintain a temperature range of -20°C to +45°C during transit.
- * Avoid mixing the battery with explosive, flammable, or toxic substances.
- * Use van-type vehicles like containers or metallic vans; platform vehicles and convertibles are prohibited.
- * Do not stack foreign objects on top of the battery; stacking up to five batteries is acceptable.
- * Keep the original packaging intact and ensure labels remain visible and legible.
- * Shield from direct sunlight, rain, condensation, and mechanical damage.

11 Appendix

11.1 A Protection Policy

No.	Item	Unit	Level 1	Level 2	Level 3
			Warming	DC/DC Protection	Battery Protection
1	Protection voltage against over charge	V	3.6	3.65	3.7
2	Over charge protection delay	s	3	4	5
3	Protection voltage against over discharge	V	3.05	3	2.8
4	Over discharge protection delay	s	3	4	5
5	Cell "0V" Under-voltage Abnormal	V	/	/	2
6	Cell "0V" Under-voltage Abnormal delay	s	/	/	10
7	Protection value against over-charging and over-discharging current	A	57.75	60.38	61.95
8	Over current protection delay	s	3	4	5
9	Short-circuit protection value	A	/	/	400
10	Short-circuit protection delay	ms	/	/	150
11	Over temperature charging protection value	°C	50	55	56
12	Over-temperature discharging protection value	°C	50	55	56
13	Over-temperature protection delay	s	3	4	5
14	Low-temperature charging protection value	°C	-10	-12	-14
15	Low-temperature discharging protection value	°C	-10	-12	-14
16	Low-temperature discharging protection delay	s	3	4	5

11.2 Technical Data

Manufacturer	SieB-H-M Battery Energy Storage System-Home (HV)		
Product Type	SieB-H9800-M	SieB-H13K1-M	SieB-H16K3-M
Nominal Energy (kWh)*1	9.83	13.11	16.38
Usable Energy (kWh)*2	9.334	12.45	15.56
Module Type	SieB-H3277-M		
Module Parameter	51.2V64Ah 440*380*131mm 27kg		
Cell Type	LFP (LiFePO ₄)		
Nominal Capacity (Ah)	64		
Max. Module Configuration	3	4	5
Cell Configuration	1P48S	1P64S	1P80S
Nominal Voltage (V)	153.6	204.8	256
Operating Voltage Range (V)	144~172.8	192~230.4	240~288
Max. Continuous Current (A)*3	52.5		
Max. Continuous Power (kW)*3	7.56	10.08	12.60
Communication	CAN / RS485		
Parallel Connect	A maximum of 4 racks with CAN communication		
Weight (kg)	176	206	236

Dimensions (W*D*H) (mm)		600*600*1500
Operating Temperature (°C)		-10~50
Storage Temperature (°C)		-30~60 (≤7 Days) / -20~45 (≤6 Months)
Humidity		5%~95%
Altitude (m)*3		≤2000
Enclosure Type		IP20 (Indoor)
Cooling		Natural convection
Installation Location		Floor-standing (In Cabinet)
Display		SOC indicator, Status indicator
Standard and Certification	Safety	IEC62619
	EMC	IEC61000-6-1/3
	Transportation	UN38.3
	Others	RoHS, REACH
Warranty*4		10Years
1. Test conditions: 2.5V~3.6V, 0.2C Charge (CC-CV) and Discharge at 25±3°C;		
2. Test conditions: 3.0V~3.6V, 0.2C Charge (CC-CV) and Discharge at 25±3°C;		
3. Max. Continuous Current / Power derating will occur related to Temperature / SOC / Humidity;		
4. Refer to Swatten SieB-H-M Limited Warranty Letter;		

Manufacturer	SieB-H-M Battery Energy Storage System-Home (HV)		
Product Type	SieB-H19K6-M	SieB-H22K9-M	SieB-H26K2-M
Nominal Energy (kWh)*1	19.66	22.94	26.21
Usable Energy (kWh)*2	18.67	21.79	24.89
Module Type	SieB-H3277-M		
Module Parameter	51.2V64Ah 440*380*131mm 27kg		
Cell Type	LFP (LiFePO ₄)		
Nominal Capacity (Ah)	64		
Max. Module Configuration	6	7	8
Cell Configuration	1P96S	1P112S	1P128S
Nominal Voltage (V)	307.2	358.4	409.6
Operating Voltage Range (V)	288~345.6	336~403.2	384~460.8
Max. Continuous Current (A)*3	52.5		
Max. Continuous Power (kW)*3	15.12	17.64	20.16
Communication	CAN / RS485		
Parallel Connect	A maximum of 4 racks with CAN communication		
Weight (kg)	266	296	326
Dimensions (W*D*H) (mm)	600*600*1500		
Operating Temperature (°C)	-10~50		
Storage Temperature (°C)	-30~60 (≤7 Days) / -20~45 (≤6 Months)		
Humidity	5%~95%		
Altitude (m)*3	≤2000		
Enclosure Type	IP20 (Indoor)		
Cooling	Natural convection		

Installation Location		Floor-standing (In Cabinet)
Display		SOC indicator, Status indicator
Standard and Certification	Safety	IEC62619
	EMC	IEC61000-6-1/3
	Transportation	UN38.3
	Others	RoHS, REACH
Warranty*4		10Years
1. Test conditions: 2.5V~3.6V, 0.2C Charge (CC-CV) and Discharge at 25±3°C;		
2. Test conditions: 3.0V~3.6V, 0.2C Charge (CC-CV) and Discharge at 25±3°C;		
3. Max. Continuous Current / Power derating will occur related to Temperature / SOC / Humidity;		
4. Refer to Swatten SieB-H-M Limited Warranty Letter;		